

Surfaces: Sierra Cherry finish on Cherry veneer-CRY, Mahogany finish on Walnut veneer-MAH or Charcoal finish on Oak veneer-CGR.

- All locks are keyed-alike and feature removable cores for installing keyed-different locks after-market
- Desk, Return and Extension work surfaces are 1½" thick with a distinctive beveled edge
- All veneer surfaces are protected with two coats of high-tech catalyzed lacquer
- All models in all finishes are available on Quick Ship delivery programs with no quantity limitations
- Recommended under-cabinet LED Task Light is model EZDP. Other LED Task/Desk lighting is available in the Ergonomics section page 276

DESK

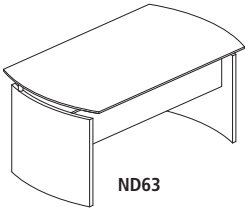

- Floating top on Silver supports
- Silver modesty panel
- Curved end panels reflect curved ends of work surface

Model No.	Dimensions	Weight	List Price
ND63	63"W x 36"D x 29½"H	155	1,586.00
ND72	72"W x 36"D x 29½"H	183	1,714.00

CURVED DESK RETURN WITH PENCIL-BOX-FILE PEDESTAL

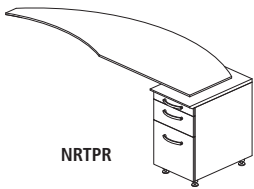

- Creates L-shaped work surface when attached to Desk
- Available for right or left side of Desk
- Gang-lock features removable core
- Supported by Return Pencil-Box-File Pedestal
- Pedestal drawer interiors finished to match exterior veneer

Model No.	Description	Dimensions	Weight	List Price
NRTPR	63" Right Return	63"W x 24"D x 29½"H	123	1,602.00
NRTPL	63" Left Return	63"W x 24"D x 29½"H	123	1,602.00

CURVED DESK EXTENSION

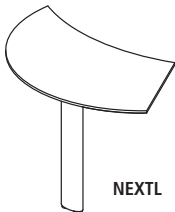

- Creates conference end to Napoli Desk
- Leg includes grommets for cable management
- Supported by Silver leg
- Available for right or left side of Desk

Model No.	Description	Dimensions	Weight	List Price
NEXTR	Right Extension	47"W x 28"D x 29½"H	51	727.00
NEXTL	Left Extension	47"W x 28"D x 29½"H	51	727.00

CREDENZA

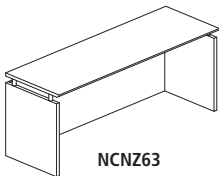

Model No.	Description	Dimensions	Weight	List Price
NCNZ63	Credenza	63"W x 24"D x 29½"H	133	1,374.00
NCNZ72	Credenza	72"W x 24"D x 29½"H	151	1,482.00

BRIDGE

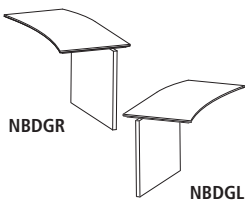

- Not free standing. Requires connection to Credenza and Desk

Model No.	Description	Dimensions	Weight	List Price
NBDGR	Right Hand Bridge	48"W x 24"D x 29½"H	68	864.00
NBDGL	Left Hand Bridge	48"W x 24"D x 29½"H	68	864.00

HUTCH

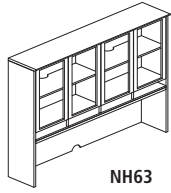

NH63

- Clear glass doors with Silver frames
- Four open compartment slots accept optional trays
- Provides 19¾" H clearance below shelf
- Two, 12" H storage levels
- Fully assembled

Model No.	Dimensions	Weight	List Price
NH63	63" W x 15" D x 50½" H	183	2,953.00
NH72	72" W x 15" D x 50½" H	209	3,128.00

NOTE: Recommended under-cabinet LED Task Light is model EZDP. Other LED Task/Desk lighting is available in the Ergonomics section page 276.

FABRIC PANELS

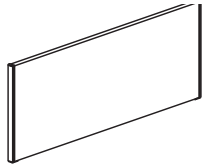

- Stocked in MIR1454 Birch Fabric

Model No.	Dimensions	Weight	List Price
FTB63	60" W x 18½" H	15	597.00
FTB72	69" W x 18½" H	16	597.00

CENTER DESK DRAWER

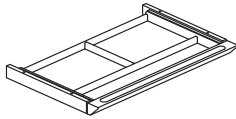

- Solid wood frame construction. Leather lined interior compartments
- Drawer operates smoothly using full-extension ball-bearing suspension
- Beveled front edge to match Desk surface design

Model No.	Description	Dimensions	Weight	List Price
NCD	Center Drawer	30" W x 18" D x 2" H	10	297.00

PEDESTALS



NBBF

- Drawer interiors finished to match exterior veneer
- Drawers operate smoothly using full-extension ball-bearing suspensions
- Fits under Credenzas
- Gang-lock features removable core
- Finished top surface

Model No.	Description	Dimensions	Weight	List Price
NBBF	Box/Box/File Pedestal	15¼" W x 21¼" D x 26" H	80	1,094.00
NFF	File/File Pedestal	15¼" W x 21¼" D x 26" H	78	1,042.00

MOBILE PEDESTALS

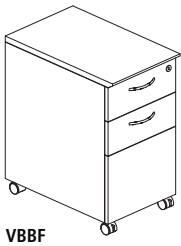

VBBF

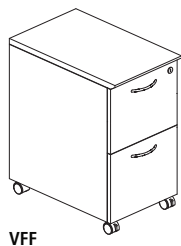

VFF

- Choice of two styles featuring two file drawers or two box drawers and one file drawer
- File drawers accommodate letter- and legal-sized hanging file folders
- Includes counter-weight for stability when in use
- Drawers operate smoothly using full-extension ball-bearing suspensions
- Gang-lock features removable core enabling keyed-alike suites
- 2" dual-hooded casters. (2 lock, 2 non-lock)

Model No.	Description	Dimensions	Weight	List Price
VBBF	Box/Box/File Pedestal	15¼" W x 24" D x 27½" H	92	1,086.00
VFF	File/File Pedestal	15¼" W x 24" D x 27½" H	80	1,053.00



These products are subject to California Proposition 65. Please visit the product detail page on our website for specific information.

LATERAL FILE  

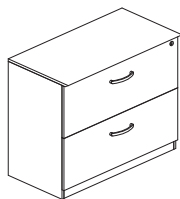

- Accommodate letter- and legal-sized hanging file folders
- Includes counter-weight for stability when in use
- Gang-lock features removable core enabling keyed-alike suites
- Drawers operate smoothly using full-extension ball-bearing suspensions

Model No.	Description	Dimensions	Weight	List Price
VLF	File/File Lateral File	36"W x 19"D x 29½"H	160	1,904.00

WARDROBE CABINETS  



- Universal Door can either hinge on either right or left
- Interior features sliding wardrobe hanging bar
- Includes one fixed shelf and three adjustable shelves (1¼" increments)

Model No.	Description	Dimensions	Weight	List Price
VWRD	Wardrobe Cabinets with Universal Door	23¾"W x 19"D x 80"H	180	2,093.00

HIGH WALL CABINET WITH DOORS  

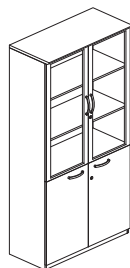

- Features glass doors with Silver frame above wood doors
- Top and bottom doors lock separately. Keyed alike
- Includes two adjustable shelves in top section and one adjustable shelf in lower section
- Able to stand alone or be flanked by Wardrobe Cabinets

Model No.	Description	Dimensions	Weight	List Price
VHC	High Wall Cabinet with Doors	40"W x 19"D x 80"H	284	3,329.00

68" WALL CABINET  

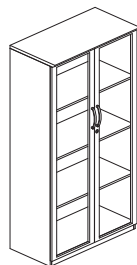

- With glass doors
- Includes one fixed shelf and two adjustable shelves

Model No.	Description	Dimensions	Weight	List Price
VCG	Wall Cabinet with Glass Doors	36"W x 19"D x 68"H	253	2,327.00

LOW WALL CABINET WITH DOORS

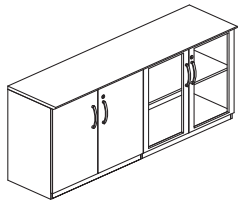

- Features a choice of wood/glass, all wood or all glass door sets
- Sets of doors lock separately. Keyed alike
- Includes one adjustable shelf on each side

Model No.	Description	Dimensions	Weight	List Price
VLC	Wood/Glass Door Combination	72"W x 19"D x 29½"H	193	2,247.00
VLCW	All Wood Doors	72"W x 19"D x 29½"H	193	2,247.00
VLCG	All Glass Doors	72"W x 19"D x 29½"H	193	2,247.00

BOOKCASES

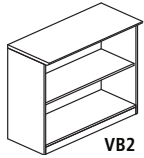

VB2

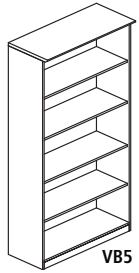

VB5

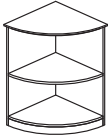

VBQ2

- Open shelves for convenient storage
- Adjustable shelves
- Choice of two or five shelf units
- 1" thick shelves
- VB2 & VB5 support 75 lbs. per shelf, evenly distributed; VBQ2 supports 25 lbs. per shelf, evenly distributed

Model No.	Description	Dimensions	Weight	List Price
VB2	2 Shelf	36"W x 11½"D x 29½"H	64	925.00
VB5	5 Shelf	36"W x 11½"D x 68"H	140	1,791.00
VBQ2	2 Shelf ¼ - Round	19"W x 19"D x 29½"H	25	869.00

NAPOLI RECEPTION FURNITURE

Surfaces: Sierra Cherry finish on Cherry veneer-CRY, Mahogany finish on Walnut veneer-MAH and Charcoal finish on Oak veneer-CGR

- All Napoli Reception Stations (except NRS) include a center drawer
- ¾" frosted, tempered glass
- Non-handed return
- Universal ADA Reception Return can only be used with Napoli Reception Station

Model No.	Description	Dimensions	Weight	List Price
NRS	Reception Station	87¼"W x 37¼"D x 42¾"H	398	3,909.00
NRSBF	Reception Station with Box/Box/File, File/File Pedestal	87¼"W x 37¼"D x 42¾"H	577	6,237.00
NRSBB	Reception Station with 2-Box/Box/File Pedestal	87¼"W x 37¼"D x 42¾"H	562	6,272.00
NRSLBF	Reception Station with Box/Box/File, File/File Pedestal	87¼"W x 37¼"D x 42¾"H Desk 48"W x 25"D x 39¼"H Return	980	8,175.00
NRSLBB	Reception Station with 2-Box/Box/File Pedestal	87¼"W x 37¼"D x 42¾"H Desk 48"W x 25"D x 39¼"H Return	980	8,188.00
NRSLFF	Reception Station with 2-File/File Pedestal	87¼"W x 37¼"D x 42¾"H Desk 48"W x 25"D x 39¼"H Return	980	8,141.00
NRSLBA	Reception Station with 1-Box/Box/File Pedestal	87¼"W x 37¼"D x 42¾"H Desk	553	5,815.00
NRTNA	Universal ADA Return	38"W x 20½"D x 28¾"H	64	577.00

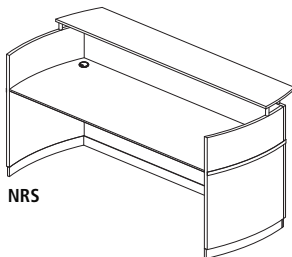

NRS

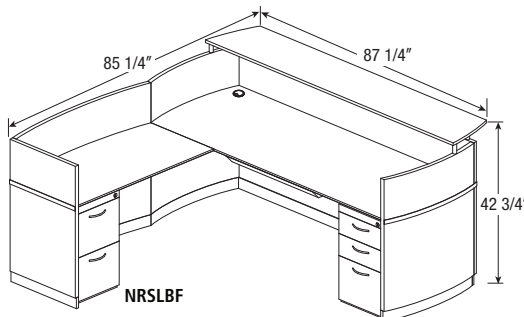

NRSLBF

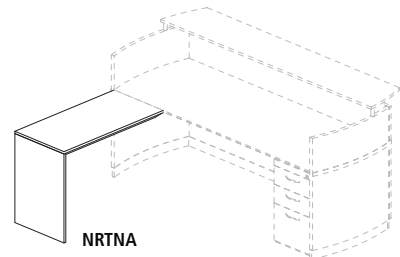

NRTNA

NAPOLI CONFERENCE TABLES  

Available in three finishes, Napoli features AA-grade select North American hardwood veneers.

Surfaces: Sierra Cherry finish on Cherry veneer-CRY, Mahogany finish on Walnut veneer-MAH and Charcoal finish on Oak veneer-CGR

- All veneer surfaces are protected with two coats of high-tech catalyzed lacquer
- Grommet hole cutout size is 2 3/4" x 6"

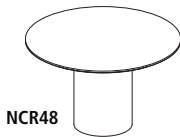

Model No.	Description	Dimensions	Weight	List Price
NC6	6' Conference Table	72"W x 36"D x 29 1/2"H	197	2,218.00
NC8	8' Conference Table	96"W x 42"D x 29 1/2"H	236	2,759.00
NC10	10' Conference Table	120"W x 48"D x 29 1/2"H	306	3,904.00
NC12	12' Conference Table	144"W x 54"D x 29 1/2"H	358	6,361.00
NC14	14' Conference Table	168"W x 54"D x 29 1/2"H	399	6,659.00
NC18	18' Conference Table	216"W x 54"D x 29 1/2"H	545	9,507.00
NC20	20' Conference Table	240"W x 54"D x 29 1/2"H	585	9,518.00
NCR48	Round Conference Table	48" Diameter x 29 1/2"H	135	1,833.00
CTMB	Presentation Board	48 x 48 x 3 1/4"	110	1,965.00



NC6

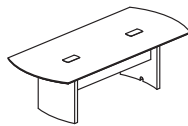

NC8

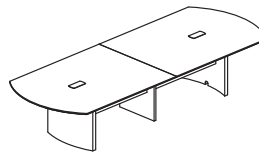

NC12

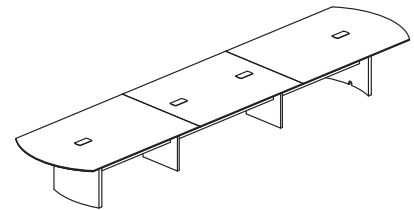

NC20

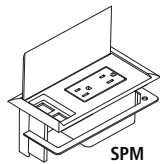

SPM

Model No.	Description	List Price
SPM 	6 1/4"W x 4"D x 1 1/2"H Optional Power Module, UL Listed [includes RJ11-Cat 3 Coupler (phone) and RJ45 Coupler (data)] – 6' Power Cord. Black only.	332.00

BUFFET  

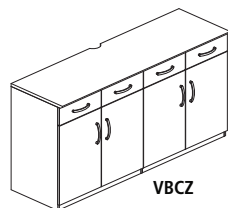

VBCZ

- Features two cabinet compartments (one adjustable shelf in each) and four drawers
- Designed for audio/visual support including cable pass throughs and inset back panel for wall plug clearance
- All drawer and cabinet interiors are full-finished veneer

Model No.	Description	Dimensions	Weight	List Price
VBCZ	Buffet	72"W x 22"D x 36"H	297	3,597.00

REPLACEMENT LOCK CORES  

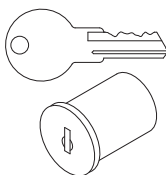

- Allows pedestals and laterals to be keyed uniquely for up to fifteen different workstations
- Master key available
- Must purchase a core removal tool to change locks cores

Model No.	Description	Weight	List Price
REALCC0311 through REALCC0325	Replacement Core with Keys, Silver	1	29.00
REALCRK	Core Removal Tool	1	29.00
REALCMK	Master Key	1	29.00

Office Suites
Seating
Tables & Desks
Meeting Essentials
Personal Organization
Ergonomics
High Density Storage
Storage & Filing
Facilities
Technology Furniture
Art & Engineering
K-12 Education