

# e5™ Work Surfaces and Supports - Kits

## e5™ WORK SURFACES AND SUPPORTS – KITS GSA

Make specifying easy with kits that are ordered under one model number.

- All e5 work surfaces in kits are available in HPL options. Add "H" after the size in the model no., i.e. EZ4824HLL and add \$50 list. If choose HPL need to pick edge color, see page 40
- Assemblies consist of a work surface, support, surface support channel and optional modesty panels
- All kits include hardware and installation instructions
- Optional modesty panels are available in frosted acrylic or laminate with attachment hardware included
- Short legs are intended to be used with Layered Height Storage Cabinets page 67

### HOW TO SPECIFY:

Select Model No. (ie., EZ4824LL)

**OPTION 1** Select Modesty Panel if desired (Add Suffix)  
ML (Laminate Panel); MA (Acrylic Panel)

**OPTION 2** Select Laminate  
See page 11 for colors  
HPL option add "H" after size

**OPTION 3** Select Paint Finish for metal parts  
TKSV (Tech Silver); BLCK (Black); WHIT (White)

### RECTANGULAR SURFACE/LEG GSA

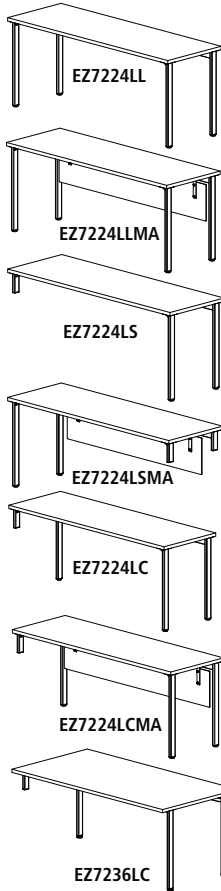

| Model No.                                   | Dimensions          | List Price | Laminate Modesty Panel (+ML) | Acrylic Modesty Panel (+MA) |
|---|---------------------|------------|------------------------------|-----------------------------|
| <b>Surface/4 Standard Legs</b>              |                     |            |                              |                             |
| EZ4824LL                                    | 48"W x 24"D x 29½"H | 655.00     | 991.00                       | 1,114.00                    |
| EZ6024LL                                    | 60"W x 24"D x 29½"H | 688.00     | 1,059.00                     | 1,317.00                    |
| EZ7224LL                                    | 72"W x 24"D x 29½"H | 729.00     | 1,112.00                     | 1,383.00                    |
| EZ4830LL                                    | 48"W x 30"D x 29½"H | 662.00     | 997.00                       | 1,120.00                    |
| EZ6030LL                                    | 60"W x 30"D x 29½"H | 694.00     | 1,066.00                     | 1,151.00                    |
| EZ7230LL                                    | 72"W x 30"D x 29½"H | 739.00     | 1,123.00                     | 1,394.00                    |
| EZ6036LL                                    | 60"W x 36"D x 29½"H | 747.00     | 1,118.00                     | 1,374.00                    |
| EZ7236LL                                    | 72"W x 36"D x 29½"H | 795.00     | 1,178.00                     | 1,446.00                    |
| <b>Surface/2 Standard Legs/2 Short Legs</b> |                     |            |                              |                             |
| EZ4824LS                                    | 48"W x 24"D x 29½"H | 622.00     | 953.00                       | 1,052.00                    |
| EZ6024LS                                    | 60"W x 24"D x 29½"H | 654.00     | 994.00                       | 1,284.00                    |
| EZ7224LS                                    | 72"W x 24"D x 29½"H | 695.00     | 1,072.00                     | 1,340.00                    |
| EZ4830LS                                    | 48"W x 30"D x 29½"H | 629.00     | 959.00                       | 1,058.00                    |
| EZ6030LS                                    | 60"W x 30"D x 29½"H | 661.00     | 1,000.00                     | 1,290.00                    |
| EZ7230LS                                    | 72"W x 30"D x 29½"H | 707.00     | 1,082.00                     | 1,352.00                    |
| EZ6036LS                                    | 60"W x 36"D x 29½"H | 714.00     | 1,053.00                     | 1,339.00                    |
| EZ7236LS                                    | 72"W x 36"D x 29½"H | 762.00     | 1,139.00                     | 1,404.00                    |
| <b>Surface/3 Standard Legs/1 Short Leg</b>  |                     |            |                              |                             |
| EZ4824LC                                    | 48"W x 24"D x 29½"H | 644.00     | 979.00                       | 1,103.00                    |
| EZ6024LC                                    | 60"W x 24"D x 29½"H | 676.00     | 1,048.00                     | 1,306.00                    |
| EZ7224LC                                    | 72"W x 24"D x 29½"H | 717.00     | 1,100.00                     | 1,373.00                    |
| EZ6030LC                                    | 60"W x 30"D x 29½"H | 683.00     | 1,054.00                     | 1,313.00                    |
| EZ7230LC                                    | 72"W x 30"D x 29½"H | 728.00     | 1,111.00                     | 1,382.00                    |
| EZ6036LC                                    | 60"W x 36"D x 29½"H | 735.00     | 1,106.00                     | 1,362.00                    |
| EZ7236LC                                    | 72"W x 36"D x 29½"H | 784.00     | 1,167.00                     | 1,436.00                    |

### RECTANGULAR SURFACE/FULL END PANEL GSA

- An HPL option is not available as standard for e5 kits with full end panels. Call for quotation if this is required.

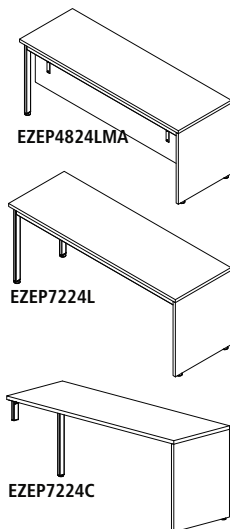

| Model No.   | Dimensions          | List Price | Laminate Modesty Panel (+ML) | Acrylic Modesty Panel (+MA) |
|---|---------------------|------------|------------------------------|-----------------------------|
| <b>Surface/End Panel/2 Standard Legs</b>            |                     |            |                              |                             |
| EZEP4824L   | 48"W x 24"D x 29½"H | 659.00     | 994.00                       | 1,117.00                    |
| EZEP6024L   | 60"W x 24"D x 29½"H | 705.00     | 1,075.00                     | 1,333.00                    |
| EZEP7224L   | 72"W x 24"D x 29½"H | 810.00     | 1,193.00                     | 1,460.00                    |
| EZEP4830L   | 48"W x 30"D x 29½"H | 815.00     | 1,150.00                     | 1,266.00                    |
| EZEP6030L   | 60"W x 30"D x 29½"H | 759.00     | 1,130.00                     | 1,384.00                    |
| EZEP7230L   | 72"W x 30"D x 29½"H | 824.00     | 1,207.00                     | 1,474.00                    |
| EZEP6036L   | 60"W x 36"D x 29½"H | 815.00     | 1,187.00                     | 1,438.00                    |
| EZEP7236L   | 72"W x 36"D x 29½"H | 880.00     | 1,263.00                     | 1,527.00                    |
| <b>Surface/End Panel/1 Standard Leg/1 Short Leg</b> |                     |            |                              |                             |
| EZEP4824C   | 48"W x 24"D x 29½"H | 647.00     | 982.00                       | 1,106.00                    |
| EZEP6024C   | 60"W x 24"D x 29½"H | 692.00     | 1,064.00                     | 1,321.00                    |
| EZEP7224C   | 72"W x 24"D x 29½"H | 798.00     | 1,182.00                     | 1,450.00                    |
| EZEP4830C   | 48"W x 30"D x 29½"H | 804.00     | 1,139.00                     | 1,255.00                    |
| EZEP6030C   | 60"W x 30"D x 29½"H | 747.00     | 1,118.00                     | 1,374.00                    |

RECTANGULAR SURFACE/FULL END PANEL SUPPORT KITS 

HOW TO SPECIFY:

Select Model No. (ie., EZEP7230C)

**OPTION 1** Select Modesty Panel if desired (Add Suffix)  
ML (Laminate Panel); MA (Acrylic Panel)

**OPTION 2** Select Laminate  
See page 40 for colors  
HPL option add "H" after size

**OPTION 3** Select Paint Finish for metal parts  
TKSV (Tech Silver); BLCK (Black); WHIT (White)

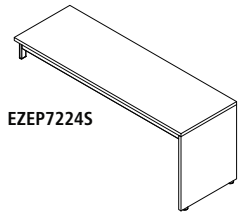

EZEP7224S

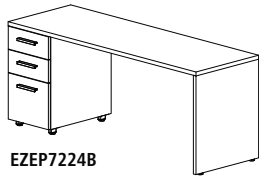

EZEP7224B

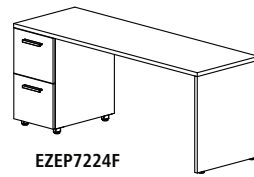

EZEP7224F

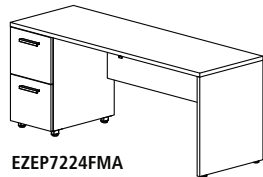

EZEP7224FMA

| Model No.   | Dimensions          | List Price | Laminate Modesty Panel (+ML) | Acrylic Modesty Panel (+MA) |
|---|---------------------|------------|------------------------------|-----------------------------|
| <b>Surface/End Panel/1 Standard Leg/1 Short Leg (continued)</b> |                     |            |                              |                             |
| EZEP7230C   | 72"W x 30"D x 29½"H | 811.00     | 1,194.00                     | 1,461.00                    |
| EZEP6036C   | 60"W x 36"D x 29½"H | 804.00     | 1,175.00                     | 1,428.00                    |
| EZEP7236C   | 72"W x 36"D x 29½"H | 868.00     | 1,251.00                     | 1,488.00                    |
| <b>Surface/End Panel/2 Short Legs</b>                           |                     |            |                              |                             |
| EZEP4824S   | 48"W x 24"D x 29½"H | 625.00     | 956.00                       | 1,055.00                    |
| EZEP6024S   | 60"W x 24"D x 29½"H | 671.00     | 1,010.00                     | 1,298.00                    |
| EZEP7224S   | 72"W x 24"D x 29½"H | 777.00     | 1,153.00                     | 1,417.00                    |
| EZEP4830S   | 48"W x 30"D x 29½"H | 783.00     | 1,113.00                     | 1,204.00                    |
| EZEP6030S   | 60"W x 30"D x 29½"H | 725.00     | 1,065.00                     | 1,352.00                    |
| EZEP7230S   | 72"W x 30"D x 29½"H | 790.00     | 1,167.00                     | 1,431.00                    |
| EZEP6036S   | 60"W x 36"D x 29½"H | 783.00     | 1,121.00                     | 1,405.00                    |
| EZEP7236S   | 72"W x 36"D x 29½"H | 847.00     | 1,223.00                     | 1,484.00                    |
| <b>Surface/End Panel/BBF Pedestal</b>                           |                     |            |                              |                             |
| EZEP4824B   | 48"W x 24"D x 29½"H | 1,387.00   | 1,707.00                     | 1,726.00                    |
| EZEP6024B   | 60"W x 24"D x 29½"H | 1,433.00   | 1,767.00                     | 1,853.00                    |
| EZEP7224B   | 72"W x 24"D x 29½"H | 1,536.00   | 1,908.00                     | 2,124.00                    |
| EZEP4830B   | 48"W x 30"D x 29½"H | 1,600.00   | 1,918.00                     | 1,929.00                    |
| EZEP6030B   | 60"W x 30"D x 29½"H | 1,544.00   | 1,878.00                     | 1,957.00                    |
| EZEP7230B   | 72"W x 30"D x 29½"H | 1,605.00   | 1,977.00                     | 2,190.00                    |
| EZEP6036B   | 60"W x 36"D x 29½"H | 1,672.00   | 2,007.00                     | 2,080.00                    |
| EZEP7236B   | 72"W x 36"D x 29½"H | 1,735.00   | 2,105.00                     | 2,312.00                    |
| <b>Surface/End Panel/FF Pedestal</b>                            |                     |            |                              |                             |
| EZEP4824F   | 48"W x 24"D x 29½"H | 1,340.00   | 1,660.00                     | 1,683.00                    |
| EZEP6024F   | 60"W x 24"D x 29½"H | 1,385.00   | 1,720.00                     | 1,808.00                    |
| EZEP7224F   | 72"W x 24"D x 29½"H | 1,489.00   | 1,861.00                     | 2,079.00                    |
| EZEP4830F   | 48"W x 30"D x 29½"H | 1,553.00   | 1,871.00                     | 1,885.00                    |
| EZEP6030F   | 60"W x 30"D x 29½"H | 1,496.00   | 1,831.00                     | 1,912.00                    |
| EZEP7230F   | 72"W x 30"D x 29½"H | 1,558.00   | 1,930.00                     | 2,144.00                    |
| EZEP6036F   | 60"W x 36"D x 29½"H | 1,598.00   | 1,933.00                     | 2,009.00                    |
| EZEP7236F   | 72"W x 36"D x 29½"H | 1,661.00   | 2,031.00                     | 2,241.00                    |

RECTANGULAR SURFACE/SUPPORT PEDESTAL KITS 

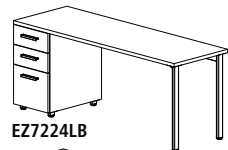

EZ7224LB

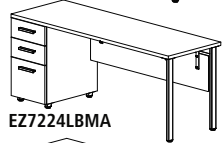

EZ7224LBMA

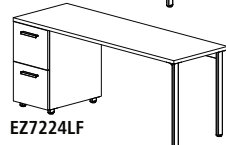

EZ7224LF

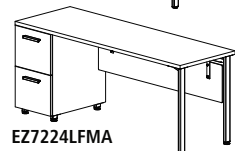

EZ7224LFMA

| Model No.                                   | Dimensions          | List Price | Laminate Modesty Panel (+ML) | Acrylic Modesty Panel (+MA) |
|---|---------------------|------------|------------------------------|-----------------------------|
| <b>Surface/BBF Pedestal/2 Standard Legs</b> |                     |            |                              |                             |
| EZ4824LB                                    | 48"W x 24"D x 29½"H | 1,385.00   | 1,704.00                     | 1,724.00                    |
| EZ6024LB                                    | 60"W x 24"D x 29½"H | 1,416.00   | 1,751.00                     | 1,837.00                    |
| EZ7224LB                                    | 72"W x 24"D x 29½"H | 1,458.00   | 1,830.00                     | 2,050.00                    |
| EZ6030LB                                    | 60"W x 30"D x 29½"H | 1,479.00   | 1,814.00                     | 1,897.00                    |
| EZ7230LB                                    | 72"W x 30"D x 29½"H | 1,525.00   | 1,897.00                     | 2,113.00                    |
| EZ6036LB                                    | 60"W x 36"D x 29½"H | 1,603.00   | 1,938.00                     | 2,014.00                    |
| EZ7236LB                                    | 72"W x 36"D x 29½"H | 1,652.00   | 2,024.00                     | 2,234.00                    |
| <b>Surface/FF Pedestal/2 Standard Legs</b>  |                     |            |                              |                             |
| EZ4824LF                                    | 48"W x 24"D x 29½"H | 1,338.00   | 1,657.00                     | 1,680.00                    |
| EZ6024LF                                    | 60"W x 24"D x 29½"H | 1,369.00   | 1,704.00                     | 1,792.00                    |
| EZ7224LF                                    | 72"W x 24"D x 29½"H | 1,411.00   | 1,783.00                     | 2,005.00                    |
| EZ6030LF                                    | 60"W x 30"D x 29½"H | 1,432.00   | 1,766.00                     | 1,852.00                    |
| EZ7230LF                                    | 72"W x 30"D x 29½"H | 1,478.00   | 1,850.00                     | 2,068.00                    |
| EZ6036LF                                    | 60"W x 36"D x 29½"H | 1,529.00   | 1,864.00                     | 1,945.00                    |
| EZ7236LF                                    | 72"W x 36"D x 29½"H | 1,578.00   | 1,950.00                     | 2,164.00                    |

Office Suites  
Seating  
Tables  
Desks  
Meeting Essentials  
Personal Organization  
Ergonomics  
High Density Storage  
Storage & Filing  
Facilities  
Technology Furniture  
Art & Engineering

# e5™ Work Surfaces and Supports - Kits

## RECTANGULAR SURFACE/SUPPORT PEDESTAL KITS



### HOW TO SPECIFY:

Select Model No. (ie., EZ7230CB)

**OPTION 1** Select Modesty Panel if desired (Add Suffix)  
ML (Laminate Panel); MA (Acrylic Panel)

**OPTION 2** Select Laminate  
See page 40 for colors  
HPL option add "H" after size

**OPTION 3** Select Paint Finish for metal parts  
TKSV (Tech Silver); BLCK (Black); WHIT (White)

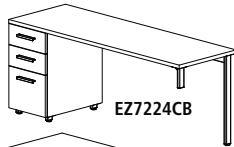

EZ7224CB

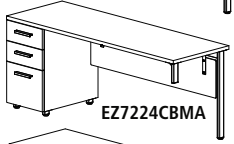

EZ7224CBMA

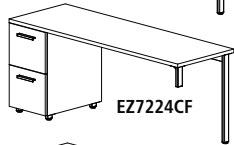

EZ7224CF

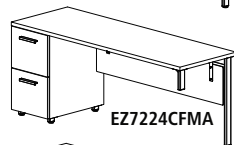

EZ7224CFMA

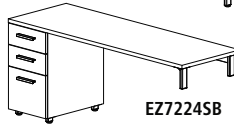

EZ7224SB

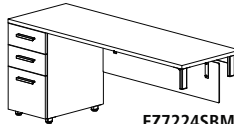

EZ7224SBMA

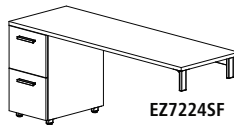

EZ7224SF

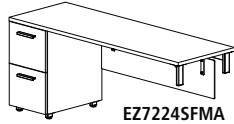

EZ7224SFMA

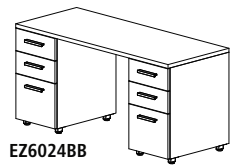

EZ6024BB



EZ6024FF

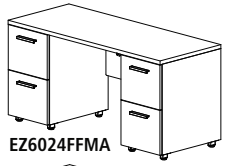

EZ6024FFMA

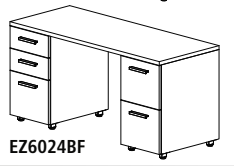

EZ6024BF

| Model No.  | Dimensions          | List Price | Laminate Modesty Panel (+ML) | Acrylic Modesty Panel (+MA) |
|--|---------------------|------------|------------------------------|-----------------------------|
| <b>Surface/BBF Pedestal/1 Standard Leg/1 Short Leg</b> |                     |            |                              |                             |
| EZ4824CB   | 48"W x 24"D x 29½"H | 1,374.00   | 1,692.00                     | 1,714.00                    |
| EZ6024CB   | 60"W x 24"D x 29½"H | 1,405.00   | 1,740.00                     | 1,826.00                    |
| EZ7224CB   | 72"W x 24"D x 29½"H | 1,447.00   | 1,818.00                     | 2,038.00                    |
| EZ6030CB   | 60"W x 30"D x 29½"H | 1,468.00   | 1,802.00                     | 1,886.00                    |
| EZ7230CB   | 72"W x 30"D x 29½"H | 1,513.00   | 1,885.00                     | 2,101.00                    |
| EZ6036CB   | 60"W x 36"D x 29½"H | 1,592.00   | 1,927.00                     | 2,004.00                    |
| EZ7236CB   | 72"W x 36"D x 29½"H | 1,641.00   | 2,012.00                     | 2,222.00                    |
| <b>Surface/FF Pedestal/1 Standard Leg/1 Short Leg</b>  |                     |            |                              |                             |
| EZ4824CF   | 48"W x 24"D x 29½"H | 1,327.00   | 1,645.00                     | 1,669.00                    |
| EZ6024CF   | 60"W x 24"D x 29½"H | 1,358.00   | 1,692.00                     | 1,782.00                    |
| EZ7224CF   | 72"W x 24"D x 29½"H | 1,400.00   | 1,771.00                     | 1,993.00                    |
| EZ6030CF   | 60"W x 30"D x 29½"H | 1,420.00   | 1,755.00                     | 1,840.00                    |
| EZ7230CF   | 72"W x 30"D x 29½"H | 1,466.00   | 1,837.00                     | 2,056.00                    |
| EZ6036CF   | 60"W x 36"D x 29½"H | 1,518.00   | 1,853.00                     | 1,933.00                    |
| EZ7236CF   | 72"W x 36"D x 29½"H | 1,567.00   | 1,938.00                     | 2,152.00                    |
| <b>Surface/BBF Pedestal/2 Short Legs</b>               |                     |            |                              |                             |
| EZ4824SB   | 48"W x 24"D x 29½"H | 1,353.00   | 1,667.00                     | 1,684.00                    |
| EZ6024SB   | 60"W x 24"D x 29½"H | 1,383.00   | 1,698.00                     | 1,775.00                    |
| EZ7224SB   | 72"W x 24"D x 29½"H | 1,425.00   | 1,764.00                     | 2,016.00                    |
| EZ6030SB   | 60"W x 30"D x 29½"H | 1,446.00   | 1,776.00                     | 1,834.00                    |
| EZ7230SB   | 72"W x 30"D x 29½"H | 1,492.00   | 1,831.00                     | 2,079.00                    |
| EZ6036SB   | 60"W x 36"D x 29½"H | 1,570.00   | 1,901.00                     | 1,952.00                    |
| EZ7236SB   | 72"W x 36"D x 29½"H | 1,620.00   | 1,958.00                     | 2,200.00                    |
| <b>Surface/FF Pedestal/2 Short Legs</b>                |                     |            |                              |                             |
| EZ4824SF   | 48"W x 24"D x 29½"H | 1,305.00   | 1,620.00                     | 1,640.00                    |
| EZ6024SF   | 60"W x 24"D x 29½"H | 1,336.00   | 1,667.00                     | 1,730.00                    |
| EZ7224SF   | 72"W x 24"D x 29½"H | 1,378.00   | 1,717.00                     | 1,971.00                    |
| EZ6030SF   | 60"W x 30"D x 29½"H | 1,399.00   | 1,728.00                     | 1,789.00                    |
| EZ7230SF   | 72"W x 30"D x 29½"H | 1,445.00   | 1,784.00                     | 2,033.00                    |
| EZ6036SF   | 60"W x 36"D x 29½"H | 1,496.00   | 1,827.00                     | 1,882.00                    |
| EZ7236SF   | 72"W x 36"D x 29½"H | 1,546.00   | 1,885.00                     | 2,130.00                    |
| <b>Surface/2 BBF Pedestals</b>                         |                     |            |                              |                             |
| EZ6024BB   | 60"W x 24"D x 29½"H | 2,145.00   | 2,460.00                     | 2,437.00                    |
| EZ7224BB   | 72"W x 24"D x 29½"H | 2,190.00   | 2,520.00                     | 2,541.00                    |
| EZ6030BB   | 60"W x 30"D x 29½"H | 2,264.00   | 2,578.00                     | 2,550.00                    |
| EZ7230BB   | 72"W x 30"D x 29½"H | 2,312.00   | 2,642.00                     | 2,657.00                    |
| EZ6036BB   | 60"W x 36"D x 29½"H | 2,460.00   | 2,774.00                     | 2,737.00                    |
| EZ7236BB   | 72"W x 36"D x 29½"H | 2,511.00   | 2,842.00                     | 2,739.00                    |
| <b>Surface/2 FF Pedestals</b>                          |                     |            |                              |                             |
| EZ6024FF   | 60"W x 24"D x 29½"H | 2,051.00   | 2,365.00                     | 2,348.00                    |
| EZ7224FF   | 72"W x 24"D x 29½"H | 2,095.00   | 2,426.00                     | 2,451.00                    |
| EZ6030FF   | 60"W x 30"D x 29½"H | 2,169.00   | 2,483.00                     | 2,463.00                    |
| EZ7230FF   | 72"W x 30"D x 29½"H | 2,217.00   | 2,548.00                     | 2,571.00                    |
| EZ6036FF   | 60"W x 36"D x 29½"H | 2,312.00   | 2,626.00                     | 2,596.00                    |
| EZ7236FF   | 72"W x 36"D x 29½"H | 2,363.00   | 2,694.00                     | 2,705.00                    |
| <b>Surface/BBF Pedestal/FF Pedestal</b>                |                     |            |                              |                             |
| EZ6024BF   | 60"W x 24"D x 29½"H | 2,098.00   | 2,412.00                     | 2,393.00                    |
| EZ7224BF   | 72"W x 24"D x 29½"H | 2,142.00   | 2,473.00                     | 2,497.00                    |
| EZ6030BF   | 60"W x 30"D x 29½"H | 2,216.00   | 2,531.00                     | 2,505.00                    |
| EZ7230BF   | 72"W x 30"D x 29½"H | 2,265.00   | 2,595.00                     | 2,613.00                    |
| EZ6036BF   | 60"W x 36"D x 29½"H | 2,386.00   | 2,700.00                     | 2,666.00                    |
| EZ7236BF   | 72"W x 36"D x 29½"H | 2,437.00   | 2,768.00                     | 2,776.00                    |

Office Suites

Seating

Tables

Desks

Meeting Essentials

Personal Organization

Ergonomics

High Density Storage

Storage & Filing

Facilities

Technology Furniture

Art & Engineering

**HOW TO SPECIFY:** Select Model No. (ie., EZHL7224LL) | **OPTION 1** Select Modesty Panel if desired (Add Suffix) ML (Laminate Panel); MA (Acrylic Panel) | **OPTION 2** Select Laminate See page 40 for colors HPL option add "H" after size | **OPTION 3** Select Paint Finish for metal parts TKSV (Tech Silver); BLCK (Black); WHIT (White)

**HATCHET SURFACE/SUPPORT KITS** 

| Model No.  | Description   | Dimensions                | List Price | Laminate Modesty Panel (+ML) | Acrylic Modesty Panel (+MA) |
|------------|---|---------------------------|------------|------------------------------|-----------------------------|
| EZHL7224LL | Hatchet Left Surface with 4 Standard Legs                   | 72"W x 36" - 24"D x 29½"H | 893.00     | 1,278.00                     | 1,529.00                    |
| EZHL7224SS | Hatchet Left Surface with 4 Short Legs                      | 72"W x 36" - 24"D x 29½"H | 828.00     | 1,199.00                     | 1,450.00                    |
| EZHL7224LC | Hatchet Left Surface with 3 Standard Legs & 1 Short Leg     | 72"W x 36" - 24"D x 29½"H | 882.00     | 1,259.00                     | 1,519.00                    |
| EZHL7224LS | Hatchet Left Surface with 2 Standard Legs & 2 Short Legs    | 72"W x 36" - 24"D x 29½"H | 861.00     | 1,238.00                     | 1,498.00                    |
| EZHL7224LB | Hatchet Left Surface with 2 Standard Legs & 1 BBF Pedestal  | 72"W x 36" - 24"D x 29½"H | 1,624.00   | 1,995.00                     | 2,207.00                    |
| EZHL7224LF | Hatchet Left Surface with 2 Standard Legs & 1 FF Pedestal   | 72"W x 36" - 24"D x 29½"H | 1,576.00   | 1,867.00                     | 2,162.00                    |
| EZHL7224SB | Hatchet Left Surface with 2 Short Legs & 1 BBF Pedestal     | 72"W x 36" - 24"D x 29½"H | 1,591.00   | 1,930.00                     | 2,172.00                    |
| EZHL7224SF | Hatchet Left Surface with 2 Short Legs & 1 FF Pedestal      | 72"W x 36" - 24"D x 29½"H | 1,544.00   | 1,882.00                     | 2,128.00                    |
| EZHR7224LL | Hatchet Right Surface with 4 Standard Legs                  | 72"W x 36" - 24"D x 29½"H | 893.00     | 1,278.00                     | 1,529.00                    |
| EZHR7224SS | Hatchet Right Surface with 4 Short Legs                     | 72"W x 36" - 24"D x 29½"H | 828.00     | 1,199.00                     | 1,450.00                    |
| EZHR7224LC | Hatchet Right Surface with 3 Standard Legs & 1 Short Leg    | 72"W x 36" - 24"D x 29½"H | 882.00     | 1,259.00                     | 1,519.00                    |
| EZHR7224LS | Hatchet Right Surface with 2 Standard Legs & 2 Short Legs   | 72"W x 36" - 24"D x 29½"H | 861.00     | 1,238.00                     | 1,498.00                    |
| EZHR7224LB | Hatchet Right Surface with 2 Standard Legs & 1 BBF Pedestal | 72"W x 36" - 24"D x 29½"H | 1,624.00   | 1,995.00                     | 2,207.00                    |
| EZHR7224LF | Hatchet Right Surface with 2 Standard Legs & 1 FF Pedestal  | 72"W x 36" - 24"D x 29½"H | 1,576.00   | 1,867.00                     | 2,162.00                    |
| EZHR7224SB | Hatchet Right Surface with 2 Short Legs & 1 BBF Pedestal    | 72"W x 36" - 24"D x 29½"H | 1,591.00   | 1,930.00                     | 2,172.00                    |
| EZHR7224SF | Hatchet Right Surface with 2 Short Legs & 1 FF Pedestal     | 72"W x 36" - 24"D x 29½"H | 1,544.00   | 1,882.00                     | 2,128.00                    |

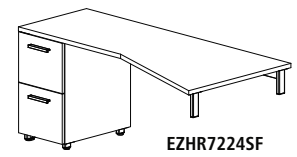
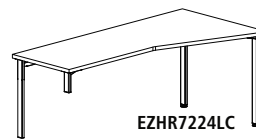
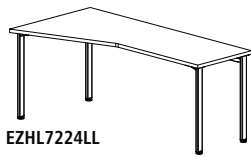

**TAPERED SURFACE/SUPPORT KITS** 

| Model No. | Description   | Dimensions                | List Price | Laminate Modesty Panel (+ML) | Acrylic Modesty Panel (+MA) |
|-----------|---|---------------------------|------------|------------------------------|-----------------------------|
| EZTL60LL  | 60" Tapered Left Surface with 4 Standard Legs                 | 60"W x 30" - 24"D x 29½"H | 732.00     | 1,103.00                     | 1,359.00                    |
| EZTL60SS  | 60" Tapered Left Surface with 4 Short Legs                    | 60"W x 30" - 24"D x 29½"H | 665.00     | 1,000.00                     | 1,124.00                    |
| EZTL60LC  | 60" Tapered Left Surface with 3 Standard Legs & 1 Short Leg   | 60"W x 30" - 24"D x 29½"H | 720.00     | 1,092.00                     | 1,348.00                    |
| EZTL60LS  | 60" Tapered Left Surface with 2 Standard Legs & 2 Short Legs  | 60"W x 30" - 24"D x 29½"H | 709.00     | 1,048.00                     | 1,335.00                    |
| EZTL72LL  | 72" Tapered Left Surface with 4 Standard Legs                 | 72"W x 30" - 24"D x 29½"H | 784.00     | 1,167.00                     | 1,436.00                    |
| EZTL72SS  | 72" Tapered Left Surface with 4 Short Legs                    | 72"W x 30" - 24"D x 29½"H | 717.00     | 1,089.00                     | 1,344.00                    |
| EZTL72LC  | 72" Tapered Left Surface with 3 Standard Legs & 1 Short Leg   | 72"W x 30" - 24"D x 29½"H | 771.00     | 1,154.00                     | 1,424.00                    |
| EZTL72LS  | 72" Tapered Left Surface with 2 Standard Legs & 2 Short Legs  | 72"W x 30" - 24"D x 29½"H | 760.00     | 1,131.00                     | 1,385.00                    |
| EZTR60LL  | 60" Tapered Right Surface with 4 Standard Legs                | 60"W x 30" - 24"D x 29½"H | 732.00     | 1,103.00                     | 1,348.00                    |
| EZTR60SS  | 60" Tapered Right Surface with 4 Short Legs                   | 60"W x 30" - 24"D x 29½"H | 665.00     | 1,000.00                     | 1,124.00                    |
| EZTR60LC  | 60" Tapered Right Surface with 3 Standard Legs & 1 Short Leg  | 60"W x 30" - 24"D x 29½"H | 720.00     | 1,092.00                     | 1,348.00                    |
| EZTR60LS  | 60" Tapered Right Surface with 2 Standard Legs & 2 Short Legs | 60"W x 30" - 24"D x 29½"H | 709.00     | 1,048.00                     | 1,335.00                    |
| EZTR72LL  | 72" Tapered Right Surface with 4 Standard Legs                | 72"W x 30" - 24"D x 29½"H | 784.00     | 1,167.00                     | 1,436.00                    |
| EZTR72SS  | 72" Tapered Right Surface with 4 Short Legs                   | 72"W x 30" - 24"D x 29½"H | 717.00     | 1,089.00                     | 1,344.00                    |
| EZTR72LC  | 72" Tapered Right Surface with 3 Standard Legs & 1 Short Leg  | 72"W x 30" - 24"D x 29½"H | 771.00     | 1,154.00                     | 1,424.00                    |
| EZTR72LS  | 72" Tapered Right Surface with 2 Standard Legs & 2 Short Legs | 72"W x 30" - 24"D x 29½"H | 760.00     | 1,131.00                     | 1,385.00                    |

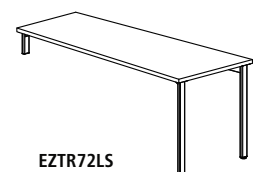
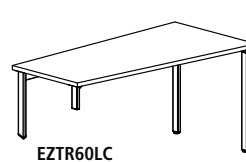
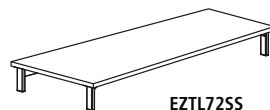
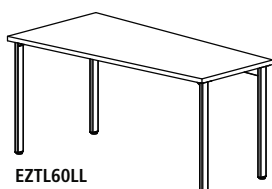

Office Suites

Seating

Tables

Desks

Meeting Essentials

Personal Organization

Ergonomics

High Density Storage

Storage & Filing

Facilities

Technology Furniture

Art & Engineering

## HOW TO SPECIFY:

Select Model No. (ie., EZ3624RR)

### OPTION 1

Select Modesty Panel if desired (Add Suffix)  
ML (Laminate Panel); MA (Acrylic Panel)

### OPTION 2

Select Laminate  
See page 40 for colors  
HPL option add "H" after size

### OPTION 3

Select Paint Finish for metal parts  
TKSV (Tech Silver); BLCK (Black); WHIT (White)

## BRIDGE SURFACE/SUPPORT KITS GSA

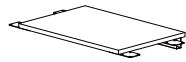

EZ3624RR



EZ3624RRMA

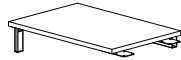

EZ3624SR

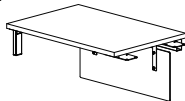

EZ3624SRMA

| Model No.  | Dimensions             | List Price | Laminate Modesty Panel (+ML) | Acrylic Modesty Panel (+MA) |
|--|------------------------|------------|------------------------------|-----------------------------|
| <b>Bridge Surface with 4 Attaching Brackets</b>                    |                        |            |                              |                             |
| EZ3624RR   | 36" W x 24" D x 29½" H | 336.00     | 654.00                       | 728.00                      |
| EZ4224RR   | 42" W x 24" D x 29½" H | 389.00     | 979.00                       | 831.00                      |
| EZ4824RR   | 48" W x 24" D x 29½" H | 433.00     | 768.00                       | 904.00                      |
| <b>Bridge Surface with 2 Short Legs &amp; 2 Attaching Brackets</b> |                        |            |                              |                             |
| EZ3624SR   | 36" W x 24" D x 29½" H | 450.00     | 768.00                       | 836.00                      |
| EZ4224SR   | 42" W x 24" D x 29½" H | 468.00     | 798.00                       | 906.00                      |
| EZ4824SR   | 48" W x 24" D x 29½" H | 515.00     | 849.00                       | 980.00                      |

## RETURN SURFACE/SUPPORT KITS GSA

- For returns with full end panels the HPL standard is not available. Call for quotation if HPL is a requirement

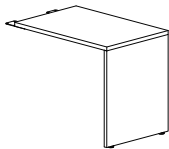

EZEP3624R

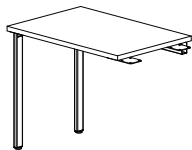

EZ3624LR

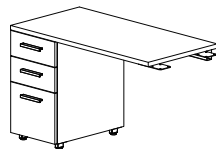

EZ4824RB

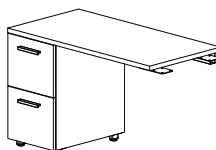

EZ4824RF

| Model No.   | Description                   | Dimensions             | List Price | Laminate Modesty Panel (+ML) | Acrylic Modesty Panel (+MA) |
|---|-------------------------------|------------------------|------------|------------------------------|-----------------------------|
| <b>Return Surface with Full End Panel &amp; 2 Attaching Brackets</b>          |                               |                        |            |                              |                             |
| EZEP3624R   | Surface/24" End Panel/Bracket | 36" W x 24" D x 29½" H | 471.00     | 790.00                       | 847.00                      |
| EZEP4224R   | Surface/24" End Panel/Bracket | 42" W x 24" D x 29½" H | 504.00     | 839.00                       | 940.00                      |
| EZEP4824R   | Surface/24" End Panel/Bracket | 48" W x 24" D x 29½" H | 549.00     | 884.00                       | 1,013.00                    |
| EZEP3630R   | Surface/30" End Panel/Bracket | 36" W x 30" D x 29½" H | 530.00     | 849.00                       | 912.00                      |
| EZEP4230R   | Surface/30" End Panel/Bracket | 42" W x 30" D x 29½" H | 571.00     | 902.00                       | 1,003.00                    |
| EZEP4830R   | Surface/30" End Panel/Bracket | 48" W x 30" D x 29½" H | 707.00     | 1,041.00                     | 1,163.00                    |
| <b>Return Surface with 2 Standard Legs &amp; 2 Attaching Brackets</b>         |                               |                        |            |                              |                             |
| EZ3624LR  | Surface/Standard Legs/Bracket | 36" W x 24" D x 29½" H | 483.00     | 802.00                       | 867.00                      |
| EZ4224LR  | Surface/Standard Legs/Bracket | 42" W x 24" D x 29½" H | 501.00     | 832.00                       | 937.00                      |
| EZ4824LR  | Surface/Standard Legs/Bracket | 48" W x 24" D x 29½" H | 547.00     | 882.00                       | 1,011.00                    |
| EZ3630LR  | Surface/Standard Legs/Bracket | 36" W x 30" D x 29½" H | 473.00     | 792.00                       | 859.00                      |
| EZ4230LR  | Surface/Standard Legs/Bracket | 42" W x 30" D x 29½" H | 511.00     | 842.00                       | 948.00                      |
| EZ4830LR  | Surface/Standard Legs/Bracket | 48" W x 30" D x 29½" H | 554.00     | 888.00                       | 1,018.00                    |
| <b>Return Surface with 2 Attaching Brackets &amp; 1 Box/Box/File Pedestal</b> |                               |                        |            |                              |                             |
| EZ4824RB  | Return/BBF Pedestal/Bracket   | 48" W x 24" D x 29½" H | 1,275.00   | 1,590.00                     | 1,621.00                    |
| EZ4830RB  | Return/BBF Pedestal/Bracket   | 48" W x 30" D x 29½" H | 1,337.00   | 1,656.00                     | 1,679.00                    |
| <b>Return Surface with 2 Attaching Brackets &amp; 1 File/File Pedestal</b>    |                               |                        |            |                              |                             |
| EZ4824RF  | Return/FF Pedestal/Bracket    | 48" W x 24" D x 29½" H | 1,227.00   | 1,547.00                     | 1,575.00                    |
| EZ4830RF  | Return/FF Pedestal/Bracket    | 48" W x 30" D x 29½" H | 1,290.00   | 1,608.00                     | 1,635.00                    |

**HOW TO SPECIFY:** Select Model No. (ie., EZ4824LW) | **OPTION 1** Select Modesty Panel if desired (Add Suffix) ML (Laminate Panel); MA (Acrylic Panel) | **OPTION 2** Select Laminate See page 40 for colors HPL option add "H" after size | **OPTION 3** Select Paint Finish for metal parts TKS (Tech Silver); BLCK (Black); WHIT (White)

**CANTILEVERED TECHNOLOGY WALL SURFACES/SUPPORT KITS** 

- Technology wall is not freestanding. Please purchase optional Foot Kit see page 75
- Short legs are intended to be used with Layered Height Storage Cabinets

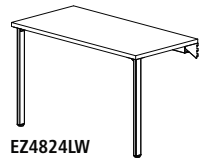

EZ4824LW



EZ7230KB

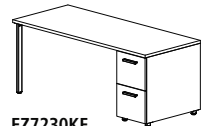

EZ7230KF



EZ4824CW

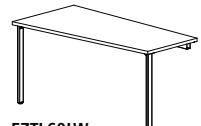

EZTL60LW

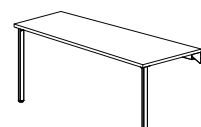

EZTR72LW

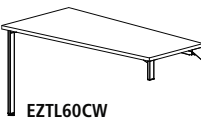

EZTL60CW

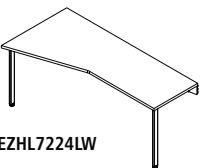

EZHL7224LW

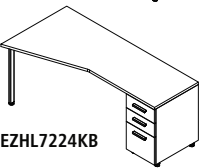

EZHL7224KB

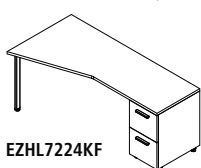

EZHL7224KF

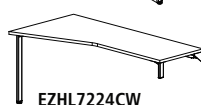

EZHL7224CW

| Model No.   | Description           | Dimensions                | List Price |
|---|-----------------------|---------------------------|------------|
| <b>Rectangular Surface with 2 Standard Legs &amp; 2 Cantilevered Brackets</b>             |                       |                           |            |
| EZ4824LW  |                       | 48"W x 24"D x 29½"H       | 535.00     |
| EZ6024LW  |                       | 60"W x 24"D x 29½"H       | 568.00     |
| EZ7224LW  |                       | 72"W x 24"D x 29½"H       | 609.00     |
| EZ4830LW  |                       | 48"W x 30"D x 29½"H       | 542.00     |
| EZ6030LW  |                       | 60"W x 30"D x 29½"H       | 574.00     |
| EZ7230LW  |                       | 72"W x 30"D x 29½"H       | 619.00     |
| <b>Rectangular Surface with 1 Standard Leg, 1 Cantilevered Bracket &amp; BBF Pedestal</b> |                       |                           |            |
| EZ4824KB  |                       | 48"W x 24"D x 29½"H       | 1,288.00   |
| EZ6024KB  |                       | 60"W x 24"D x 29½"H       | 1,308.00   |
| EZ7224KB  |                       | 72"W x 24"D x 29½"H       | 1,341.00   |
| EZ4830KB  |                       | 48"W x 30"D x 29½"H       | 1,351.00   |
| EZ6030KB  |                       | 60"W x 30"D x 29½"H       | 1,370.00   |
| EZ7230KB  |                       | 72"W x 30"D x 29½"H       | 1,408.00   |
| <b>Rectangular Surface with 1 Standard Leg, 1 Cantilevered Bracket &amp; FF Pedestal</b>  |                       |                           |            |
| EZ4824KF  |                       | 48"W x 24"D x 29½"H       | 1,241.00   |
| EZ6024KF  |                       | 60"W x 24"D x 29½"H       | 1,261.00   |
| EZ7224KF  |                       | 72"W x 24"D x 29½"H       | 1,294.00   |
| EZ4830KF  |                       | 48"W x 30"D x 29½"H       | 1,303.00   |
| EZ6030KF  |                       | 60"W x 30"D x 29½"H       | 1,323.00   |
| EZ7230KF  |                       | 72"W x 30"D x 29½"H       | 1,361.00   |
| <b>Rectangular Surface with 1 Standard Leg, 1 Short Leg &amp; 2 Cantilevered Brackets</b> |                       |                           |            |
| EZ4824CW  |                       | 48"W x 24"D x 29½"H       | 524.00     |
| EZ6024CW  |                       | 60"W x 24"D x 29½"H       | 556.00     |
| EZ7224CW  |                       | 72"W x 24"D x 29½"H       | 597.00     |
| EZ4830CW  |                       | 48"W x 30"D x 29½"H       | 530.00     |
| EZ6030CW  |                       | 60"W x 30"D x 29½"H       | 563.00     |
| EZ7230CW  |                       | 72"W x 30"D x 29½"H       | 607.00     |
| <b>Tapered Surface with 2 Standard Legs &amp; 2 Cantilevered Brackets</b>                 |                       |                           |            |
| EZTL60LW  | Tapered Surface/Left  | 60"W x 30" - 24"D x 29½"H | 612.00     |
| EZTL72LW  | Tapered Surface/Left  | 72"W x 30" - 24"D x 29½"H | 663.00     |
| EZTR60LW  | Tapered Surface/Right | 60"W x 30" - 24"D x 29½"H | 612.00     |
| EZTR72LW  | Tapered Surface/Right | 72"W x 30" - 24"D x 29½"H | 663.00     |
| <b>Tapered Surface with 1 Standard Leg, 1 Short Leg &amp; 2 Cantilevered Brackets</b>     |                       |                           |            |
| EZTL60CW  | Tapered Surface/Left  | 60"W x 30" - 24"D x 29½"H | 600.00     |
| EZTL72CW  | Tapered Surface/Left  | 72"W x 30" - 24"D x 29½"H | 651.00     |
| EZTR60CW  | Tapered Surface/Right | 60"W x 30" - 24"D x 29½"H | 600.00     |
| EZTR72CW  | Tapered Surface/Right | 72"W x 30" - 24"D x 29½"H | 651.00     |
| <b>Hatchet Surface with 2 Standard Legs &amp; 2 Cantilevered Brackets</b>                 |                       |                           |            |
| EZHL7224LW  | Hatchet Surface/Left  | 72"W x 36" - 24"D x 29½"H | 773.00     |
| EZHR7224LW  | Hatchet Surface/Right | 72"W x 36" - 24"D x 29½"H | 773.00     |
| <b>Hatchet Surface with 1 Standard Leg, 1 Cantilevered Bracket &amp; BBF Pedestal</b>     |                       |                           |            |
| EZHL7224KB  | Hatchet Surface/Left  | 72"W x 36" - 24"D x 29½"H | 1,507.00   |
| EZHR7224KB  | Hatchet Surface/Right | 72"W x 36" - 24"D x 29½"H | 1,507.00   |
| <b>Hatchet Surface with 1 Standard Leg, 1 Cantilevered Bracket &amp; FF Pedestal</b>      |                       |                           |            |
| EZHL7224KF  | Hatchet Surface/Left  | 72"W x 36" - 24"D x 29½"H | 1,459.00   |
| EZHR7224KF  | Hatchet Surface/Right | 72"W x 36" - 24"D x 29½"H | 1,459.00   |
| <b>Hatchet Surface with 1 Standard Leg, 1 Short Leg &amp; 2 Cantilevered Brackets</b>     |                       |                           |            |
| EZHL7224CW  | Hatchet Surface/Left  | 72"W x 36" - 24"D x 29½"H | 762.00     |
| EZHR7224CW  | Hatchet Surface/Right | 72"W x 36" - 24"D x 29½"H | 762.00     |

Office Suites  
Seating  
Tables  
Desks  
Meeting Essentials  
Personal Organization  
Ergonomics  
High Density Storage  
Storage & Filing  
Facilities  
Technology Furniture  
Art & Engineering

**PENINSULA TABLES** 

- 1 1/8" Thermally Fused Laminate work surfaces available in six colors with matching 2mm PVC edging
- Standing-height table can support an overhead access module (EZCA24 on page 73) that can be a passthrough to the other side of the beltway

**Laminate Colors**  
 Biltmore Cherry - LCRM  
 Cocoa - 5AGX  
 Summer Suede - 5AGY  
 White - 5AGZ  
 Walnut - 5AHA  
 Raven - 5AHB

**Leg Colors**  
 White - G5  
 Tech Silver - HK5  
 Black - S5

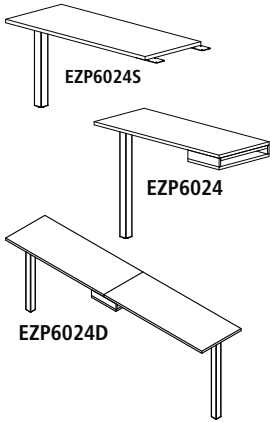

| Model No. | Description   | Dimensions          | Weight | List Price |
|-----------|---|---------------------|--------|------------|
| EZP6024S  | Peninsula Table – Standard Desk-Height with Post Leg  | 60"W x 24"D x 29½"H | 61     | 466.00     |
| EZP6024   | Peninsula Table – Standing-Height with Post Leg and underneath storage cubicle that attaches to the technology beltway. Ideal for single-sided workstations.              | 60"W x 24"D x 42"H  | 70     | 665.00     |
| EZP6024D  | Double-Sided Peninsula Table – Standing-Height with Post Leg and underneath storage cubicle that attaches to the technology beltway. Ideal for double-sided workstations. | 120"W x 24"D x 42"H | 70     | 1,285.00   |

**CREDENZAS** 

- Optional laminate or acrylic modesty panels available on page 65-66.
- Short legs are intended to be used with Layered Height Storage Cabinets.

**HOW TO SPECIFY:**

Select Model No. (ie., EZ6024LL)

**OPTION 1** Select Modesty Panel if desired (Add Suffix)  
 ML (Laminate Panel); MA (Acrylic Panel)

**OPTION 2** Select Laminate  
 See page 40 for colors  
 HPL option Add "H" after size

**OPTION 3** Select Paint Finish for metal parts  
 TKSV (Tech Silver); BLCK (Black); WHIT (White)

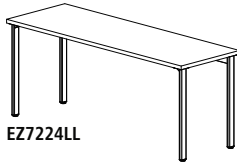

EZ7224LL

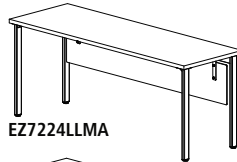

EZ7224LLMA

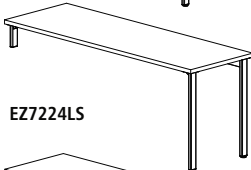

EZ7224LS

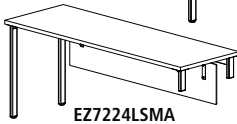

EZ7224LSMA

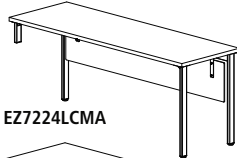

EZ7224LCMA

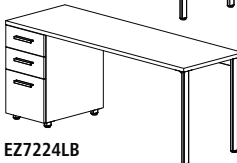

EZ7224LB

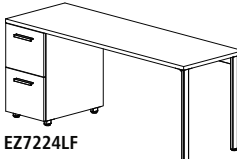

EZ7224LF

| Model No.                                   | Dimensions          | List Price | Laminate Modesty Panel (+ML) | Acrylic Modesty Panel (+MA) |
|---|---------------------|------------|------------------------------|-----------------------------|
| <b>Surface/4 Standard Legs</b>              |                     |            |                              |                             |
| EZ6024LL                                    | 60"W x 24"D x 29½"H | 688.00     | 1,059.00                     | 1,317.00                    |
| EZ7224LL                                    | 72"W x 24"D x 29½"H | 729.00     | 1,112.00                     | 1,383.00                    |
| <b>Surface/2 Standard Legs/2 Short Legs</b> |                     |            |                              |                             |
| EZ6024LS                                    | 60"W x 24"D x 29½"H | 654.00     | 994.00                       | 1,284.00                    |
| EZ7224LS                                    | 72"W x 24"D x 29½"H | 695.00     | 1,072.00                     | 1,340.00                    |
| <b>Surface/3 Standard Legs/1 Short Leg</b>  |                     |            |                              |                             |
| EZ6024LC                                    | 60"W x 24"D x 29½"H | 676.00     | 1,048.00                     | 1,306.00                    |
| EZ7224LC                                    | 72"W x 24"D x 29½"H | 717.00     | 1,100.00                     | 1,373.00                    |
| <b>Surface/2 Standard Legs/BBF Pedestal</b> |                     |            |                              |                             |
| EZ6024LB                                    | 60"W x 24"D x 29½"H | 1,416.00   | 1,751.00                     | 1,837.00                    |
| EZ7224LB                                    | 72"W x 24"D x 29½"H | 1,458.00   | 1,830.00                     | 2,050.00                    |
| <b>Surface/2 Standard Legs/FF Pedestal</b>  |                     |            |                              |                             |
| EZ6024LF                                    | 60"W x 24"D x 29½"H | 1,369.00   | 1,704.00                     | 1,792.00                    |
| EZ7224LF                                    | 72"W x 24"D x 29½"H | 1,411.00   | 1,783.00                     | 2,005.00                    |
| <b>Surface/2 Short Legs/BBF Pedestal</b>    |                     |            |                              |                             |
| EZ6024SB                                    | 60"W x 24"D x 29½"H | 1,383.00   | 1,698.00                     | 1,775.00                    |
| EZ7224SB                                    | 72"W x 24"D x 29½"H | 1,425.00   | 1,764.00                     | 2,016.00                    |
| <b>Surface/2 Short Legs/FF Pedestal</b>     |                     |            |                              |                             |
| EZ6024SF                                    | 60"W x 24"D x 29½"H | 1,336.00   | 1,667.00                     | 1,730.00                    |
| EZ7224SF                                    | 72"W x 24"D x 29½"H | 1,378.00   | 1,717.00                     | 1,971.00                    |

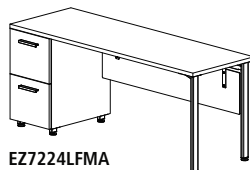

EZ7224LFMA

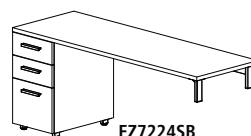

EZ7224SB

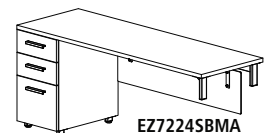

EZ7224SBMA

CREDENZAS 

• An HPL option is not available as standard for e5 kits with end panels. Call for quotation if HPL is required

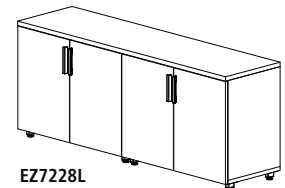
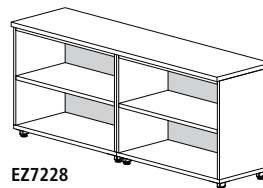
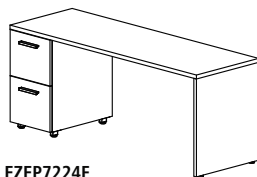
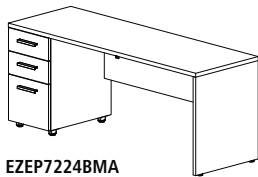
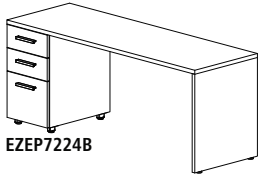
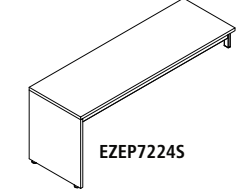
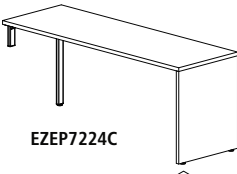
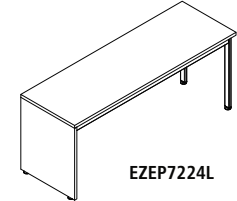
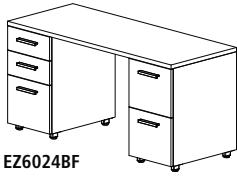
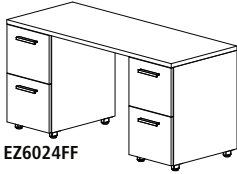
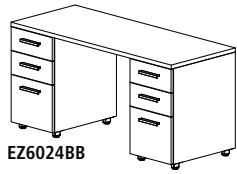

| Model No.   | Dimensions          | List Price | Laminate Modesty Panel (+ML) | Acrylic Modesty Panel (+MA) |
|---|---------------------|------------|------------------------------|-----------------------------|
| <b>Surface/2 BBF Pedestals</b>                      |                     |            |                              |                             |
| EZ6024BB  | 60"W x 24"D x 29½"H | 2,145.00   | 2,460.00                     | 2,437.00                    |
| EZ7224BB  | 72"W x 24"D x 29½"H | 2,190.00   | 2,520.00                     | 2,541.00                    |
| <b>Surface/2 FF Pedestals</b>                       |                     |            |                              |                             |
| EZ6024FF  | 60"W x 24"D x 29½"H | 2,051.00   | 2,365.00                     | 2,348.00                    |
| EZ7224FF  | 72"W x 24"D x 29½"H | 2,095.00   | 2,426.00                     | 2,451.00                    |
| <b>Surface/BBF Pedestal/FF Pedestal</b>             |                     |            |                              |                             |
| EZ6024BF  | 60"W x 24"D x 29½"H | 2,098.00   | 2,412.00                     | 2,393.00                    |
| EZ7224BF  | 72"W x 24"D x 29½"H | 2,142.00   | 2,473.00                     | 2,497.00                    |
| <b>Surface/2 Standard Legs/End Panel</b>            |                     |            |                              |                             |
| EZEP6024L   | 60"W x 24"D x 29½"H | 705.00     | 1,075.00                     | 1,333.00                    |
| EZEP7224L   | 72"W x 24"D x 29½"H | 810.00     | 1,193.00                     | 1,460.00                    |
| <b>Surface/1 Standard Leg/1 Short Leg/End Panel</b> |                     |            |                              |                             |
| EZEP6024C   | 60"W x 24"D x 29½"H | 692.00     | 1,064.00                     | 1,321.00                    |
| EZEP7224C   | 72"W x 24"D x 29½"H | 798.00     | 1,182.00                     | 1,450.00                    |
| <b>Surface/2 Short Legs/End Panel</b>               |                     |            |                              |                             |
| EZEP6024S   | 60"W x 24"D x 29½"H | 671.00     | 1,010.00                     | 1,298.00                    |
| EZEP7224S   | 72"W x 24"D x 29½"H | 777.00     | 1,153.00                     | 1,417.00                    |
| <b>Surface/End Panel/BBF Pedestal</b>               |                     |            |                              |                             |
| EZEP6024B   | 60"W x 24"D x 29½"H | 1,433.00   | 1,767.00                     | 1,853.00                    |
| EZEP7224B   | 72"W x 24"D x 29½"H | 1,536.00   | 1,908.00                     | 2,124.00                    |
| <b>Surface/End Panel/FF Pedestal</b>                |                     |            |                              |                             |
| EZEP6024F   | 60"W x 24"D x 29½"H | 1,385.00   | 1,720.00                     | 1,808.00                    |
| EZEP7224F   | 72"W x 24"D x 29½"H | 1,489.00   | 1,861.00                     | 2,079.00                    |

| Model No.  | Dimensions          | Weight | List Price | Laminate Modesty Panel (+ML) | Acrylic Modesty Panel (+MA) |
|--|---------------------|--------|------------|------------------------------|-----------------------------|
| <b>Surface-Height Storage Cabinets – Upper and Bottom Divided, Open (Two 36" Cabinets with Common 1½" Top)</b> |                     |        |            |                              |                             |
| EZ7228   | 72"W x 18"D x 29½"H | 173    | 1,942.00   | N/A                          | N/A                         |
| <b>Surface-Height Storage Cabinets – Hinged Laminate Doors (Two 36" Cabinets with Common 1½" Top)</b>          |                     |        |            |                              |                             |
| EZ7228L  | 72"W x 18"D x 29½"H | 197    | 2,362.00   | N/A                          | N/A                         |

Office Suites  
Seating  
Tables  
Desks  
Meeting Essentials  
Personal Organization  
Ergonomics  
High Density Storage  
Storage & Filing  
Facilities  
Technology Furniture  
Art & Engineering



# e5™ Standing-Height Tables

## e5™ STANDING-HEIGHT TABLES

- e5 Tables have Thermally Fused Laminate work surfaces
- All e5 worksurfaces are available in HPL options. Add "H" after the model no., i.e. EZSH4828ECH and use the HPL (+H) List Price
- See page 40 for edges for HPL
- Legs available in White, Black and Silver. Specify paint color
- Additional models provide precut hole cutouts for surface electrical or conferencing equipment. Precut holes compatible with electrical components listed On page 61. There is one cutout on 48" and 60" W tables and two cutouts on 72" and 84" W tables. No grommet cover is included; must purchase electrical kits below.
- All table assemblies consist of worksurface, support legs, surface support channels, appropriate hardware and optional specified electrical unit cutouts.

### Laminate Colors

Biltmore Cherry - LCRM  
Cocoa - 5AGX  
Summer Suede - 5AGY  
White - 5AGZ  
Walnut - 5AHA  
Raven - 5AHB

### Leg Colors

White - G5  
Tech Silver - HK5  
Black - S5

#### HOW TO SPECIFY:

Select Model No. (ie., EZSH4828EC)

#### OPTION

Select Laminate

1

See page 40 for colors  
HPL option Add "H" after model #

#### OPTION

Select Paint Finish for metal parts

2

TKSV (Tech Silver); BLCK (Black); WHIT (White)

| Model No.                                  | Descriptions/Dimensions | List     | HPL List (+H) |
|--|-------------------------|----------|---------------|
| <b>Standing-Height Tables - No Cutouts</b> |                         |          |               |
| EZSH4824                                   | 48"W x 24"D x 42"H      | 1,284.00 | 1,335.00      |
| EZSH6024                                   | 60"W x 24"D x 42"H      | 1,397.00 | 1,448.00      |
| EZSH7224                                   | 72"W x 24"D x 42"H      | 1,458.00 | 1,510.00      |
| EZSH8424                                   | 84"W x 24"D x 42"H      | 1,695.00 | 1,746.00      |
| EZSH4830                                   | 48"W x 30"D x 42"H      | 1,335.00 | 1,386.00      |
| EZSH6030                                   | 60"W x 30"D x 42"H      | 1,417.00 | 1,448.00      |
| EZSH7230                                   | 72"W x 30"D x 42"H      | 1,489.00 | 1,541.00      |
| EZSH8430                                   | 84"W x 30"D x 42"H      | 1,725.00 | 1,777.00      |
| EZSH6036                                   | 60"W x 36"D x 42"H      | 1,438.00 | 1,489.00      |
| EZSH7236                                   | 72"W x 36"D x 42"H      | 1,520.00 | 1,571.00      |
| EZSH8436                                   | 84"W x 36"D x 42"H      | 1,797.00 | 1,849.00      |

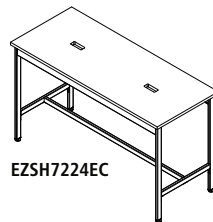
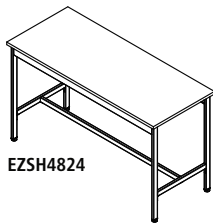

| Model No.  | Descriptions/Dimensions          | List     | HPL List (+H) |
|--|----------------------------------|----------|---------------|
| <b>Standing-Height Tables with Electrical Cutouts - each Cutout is 5/8" W x 2 L" to accommodate surface electrical kits*</b> |                                  |          |               |
| EZSH4824EC   | 48"W x 24"D x 42"H - one cutout  | 1,304.00 | 1,356.00      |
| EZSH6024EC   | 60"W x 24"D x 42"H - one cutout  | 1,417.00 | 1,469.00      |
| EZSH7224EC   | 72"W x 24"D x 42"H - two cutouts | 1,499.00 | 1,551.00      |
| EZSH8424EC   | 84"W x 24"D x 42"H - two cutouts | 1,736.00 | 1,787.00      |
| EZSH4830EC   | 48"W x 30"D x 42"H - one cutout  | 1,356.00 | 1,407.00      |
| EZSH6030EC   | 60"W x 30"D x 42"H - one cutout  | 1,438.00 | 1,469.00      |
| EZSH7230EC   | 72"W x 30"D x 42"H - two cutouts | 1,530.00 | 1,582.00      |
| EZSH8430EC   | 84"W x 30"D x 42"H - two cutouts | 1,766.00 | 1,818.00      |
| EZSH6036EC   | 60"W x 36"D x 42"H - one cutout  | 1,458.00 | 1,510.00      |
| EZSH7236EC   | 72"W x 36"D x 42"H - two cutouts | 1,561.00 | 1,612.00      |
| EZSH8436EC   | 84"W x 36"D x 42"H - two cutouts | 1,838.00 | 1,890.00      |

\* Electrical kit information is on page 32

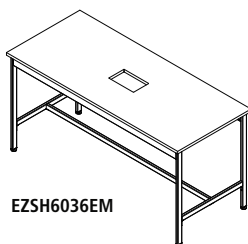

| Model No.   | Descriptions/Dimensions         | List     | HPL List (+H) |
|---|---------------------------------|----------|---------------|
| <b>Standing-Height with Meeting Unit Cutout - Cutout 7 1/2" W x 12 1/2" L</b> |                                 |          |               |
| EZSH6036EM  | 60"W x 36"D x 42"H - one cutout | 1,479.00 | 1,612.00      |
| EZSH7236EM  | 72"W x 36"D x 42"H - one cutout | 1,561.00 | 1,715.00      |
| EZSH8436EM  | 84"W x 36"D x 42"H - one cutout | 1,838.00 | 1,992.00      |

## e5™ STANDING-HEIGHT SQUARE TABLES

- All standard choices and information listed above for e5 regular Standing-Height Tables apply

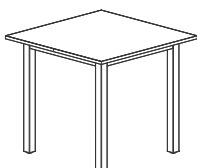

| Model No.   | Descriptions/Dimensions                | Weight | List     | HPL List (+H) |
|---|--|--------|----------|---------------|
| <b>Square Standing-Height Tables - No Factory Cutouts</b> |  |        |          |               |
| EZLS48  | Square 42"H Table - 48"W x 48"D x 42"H | 200    | 1,695.00 | 1,746.00      |
| EZLS54  | Square 42"H Table - 54"W x 54"D x 42"H | 226    | 1,772.00 | 1,823.00      |
| EZLS60  | Square 42"H Table - 60"W x 60"D x 42"H | 256    | 1,849.00 | 1,900.00      |

e5™ STANDING-HEIGHT SQUARE TABLES 

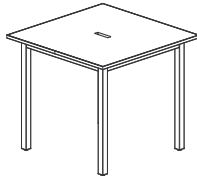

| Model No.  | Descriptions/Dimensions  | Weight | List     | HPL List (+H) |
|--|--|--------|----------|---------------|
| <b>Square Standing-Height Tables - With Factory Cutouts Only</b>             |  |        |          |               |
| EZLS48EC   | Square 42" H Table with Electrical Cutouts - 48"W x 48"D x 42"H                        | 200    | 1,725.00 | 1,777.00      |
| EZLS54EC   | Square 42" H Table with Electrical Cutouts - 54"W x 54"D x 42"H                        | 226    | 1,802.00 | 1,854.00      |
| EZLS60EC   | Square 42" H Table with Electrical Cutouts - 60"W x 60"D x 42"H                        | 256    | 1,879.00 | 1,931.00      |
| Note: Each Cutout is 2" x 8¼" to accommodate Surface Mount Electrical EZSCK4 |  |        |          |               |
| Model No.  | Descriptions/Dimensions  | Weight | List     |               |
| EZLSCK   | Set of 4 Dual-Wheel Casters with Brake Caster<br>37mm diameter; stem 5/16" - 18 x 5/8" | 2      |          | 41.00         |

**SURFACE ELECTRICAL KITS - PLUG-IN** 

- For electrical module holes to be cut at the factory order table models above ending in "EC"
- Select Silver, Gloss White or Black module cover
- One cutout on 48" W and 60" W tables; two cutouts on 72" W and 84" W tables

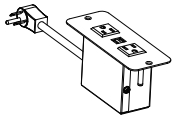

| Model No. | Description   | Power/USB Details   | List Price |
|-----------|---|---|------------|
| EZSCK     | 48" and 60" - Table Kit Silver<br>Flush Module Base, 5¼"W x 2"D | 2 power receptacles, 2 USB connectors<br>with 108" plug-in cord | 500.00     |

**SURFACE ELECTRICAL KITS - PLUG-IN (CONTINUED)** 

| Model No. | Description                          | Power/USB Details  | List Price |
|-----------|--------------------------------------|--|------------|
| EZDCK72   | 72" Table Kit<br>2 Flush Module Base | 2 power receptacles, 2 USB connectors<br>1 - 31" interconnecting cable, 1 - 72" starter cord | 1,055.00   |
| EZDCK84   | 84" Table Kit<br>2 Flush Module Base | 2 power receptacles, 2 USB connectors<br>1 - 31" interconnecting cable, 1 - 72" starter cord | 1,055.00   |

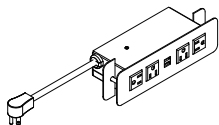

| Model No. | Description  | Power/USB Details   | List Price |
|-----------|--|---|------------|
| EZSCK4    | Keep™ Cantilevered Table Electrical Kit -<br>Flush Module Base | 4 power receptacles, 2 USB connectors<br>with 108" plug-in cord | 639.00     |

**MEETING/CONFERENCE UNITS** 

- Convert any space into a collaborative space with the portable unit, easy-to-use technology solution

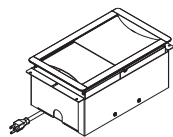

| Model No. | Description  | Dimensions            | List Price |
|-----------|--|-----------------------|------------|
| EZMR      | Grommet Mounted HDMI Stationary Unit<br>includes 4 power, 4 2.1A USB Charging Ports,<br>4 HDMI Show Me Cables, HDMI 4 position Switch Box<br>2 plate cutouts, 15' HDMI Monitor Cable and 108" Cord | 13¼" W x 8" D x 9¼" H | 9,404.00   |

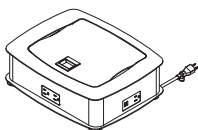

| Model No. | Description  | Dimensions              | List Price |
|-----------|--|-------------------------|------------|
| EZGA      | Portable Meeting Technology<br>includes 4 power, 4 2.1A USB Charging Ports,<br>4 HDMI Show Me Cables, HDMI 4 position Switch Box<br>15' HDMI Monitor Cable, 108" Cord and Black Carry Case | 14¾" W x 11¼" D x 4½" H | 10,541.00  |

Office Suites  
Seating  
Tables  
Desks  
Meeting Essentials  
Personal Organization  
Ergonomics  
High Density Storage  
Storage & Filing  
Facilities  
Technology Furniture  
Art & Engineering

e5™ 120° WORKSTATIONS 

- 1½" thermally fused Laminate work surfaces available in six e5 colors with matching 2mm PVC edgebanding
- All e5 120° Workstations are also available in HPL options. Add "H" after the model no., i.e. EZOT2448EH, see page 40 for edge options
- 120° e5 Workstation Pods: **Three Options** 1) Workstations with no cutouts, 2) with surface power module cutouts (power modules are ordered separately below), 3) with power beltways (order model no. EZOT2448 or EZOT3060 when using beltway)

Laminate Colors

- Biltmore Cherry - LCRM
- Cocoa - 5AGX
- Summer Suede - 5AGY
- White - 5AGZ
- Walnut - 5AHA
- Raven - 5AHB

| Model No.  | Descriptions  | Dimensions            | List     | HPL List (+H) |
|------------|---|-----------------------|----------|---------------|
| EZOT2448 * | 3 Person Pod with 120° work surfaces                            | 24" x 50" x 50" x 24" | 6,491.00 | 6,645.00      |
| EZOT2448E  | 3 Person Pod with 120° work surfaces with power/ module cutouts | 24" x 50" x 50" x 24" | 6,614.00 | 6,768.00      |
| EZOT3060 * | 3 Person Pod with 120° work surfaces                            | 30" x 62" x 62" x 30" | 7,595.00 | 7,749.00      |
| EZOT3060E  | 3 Person Pod with 120° work surfaces with power/ module cutout  | 30" x 62" x 62" x 30" | 7,718.00 | 7,872.00      |

\*Order model number when using Beltways

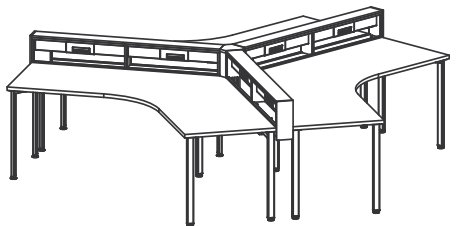

EZOT3060 with optional Beltways (see page 63)

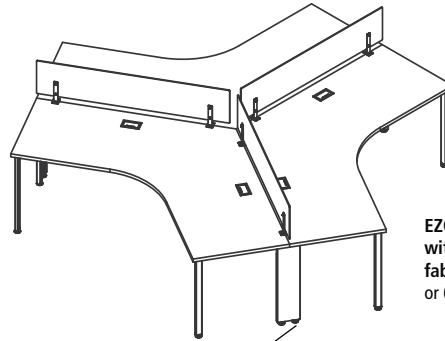

EZOT3060 with optional e5 acrylic or fabric panels. See page 65 or 66 for options.

EZDLCK

| Model No.  | Dimensions     | List Price |
|--|----------------|------------|
| <b>Leg Cover Kit</b> - optional accessory for use with plain and surface power configurations only (NOT for use with beltways) Steel choose e5 paint color see page 40 |                |            |
| EZDLCK   | 6¼" W x 27½" H | 128.00     |

POWER KITS AND BELTWAYS FOR e5 120° WORKSTATION PODS 

Surface Power Kits (Fit factory cutouts for EZOT2448E, EZOT2448EH, EZOT3060E and EZOT3060EH)

- All kits include 6 modules - 2 power 2 USB each; (5) connecting cables and 72" plug in infeed
- Modules available in Silver-S, Gloss White-W and Black-B

| Model No. | Description    | List     |
|-----------|----------------|----------|
| EZOTE48   | 48" Table Kits | 2,774.00 |
| EZOTE60   | 60" Table Kits | 2,774.00 |

**BELTWAYS FOR USE WITH EZOT2448, EZOT2448H, EZOT3060 AND EZOT3060H** 

- To connect beltways in the center of the configuration use model number EZOTCONN in one of the e5 six standard TFL colors
- Connector installs easily without tools using the same slide on bracket used with beltway cladding
- Can use both single - circuit or four - circuit beltway starter
- 3 beltways of choice will be required as there are 3 workstations

**TFL-Laminate Colors**

- Biltmore Cherry - LCRM
- Cocoa - 5AGX
- Summer Suede - 5AGY
- White - 5AGZ
- Walnut - 5AHA
- Raven - 5AHB

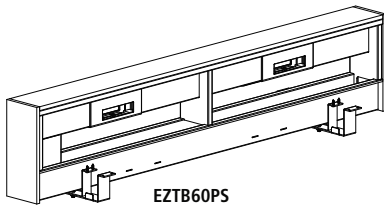

**EZTB60PS**

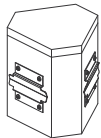

**EZOTCONN**



**EZSCL37**

| Model No.  | Dimensions  | List Price |
|--|---|------------|
| <b>Single-Circuit- Starters only - three required per three person pod</b>   |   |            |
| <b>Order (three) Starters include one 72" plug-in infeed cable, two dual-sided power blocks and four data plate cut-outs</b> |   |            |
| EZTB48PS   | 48"W x 5¼"D x 12¾"H   | 1,652.00   |
| EZTB60PS   | 60"W x 5¼"D x 12¾"H   | 1,744.00   |
| <b>4-Circuit-Beltways - 1 starter/2 adders required per three person pod</b>   |   |            |
| <b>Order (1) Starters include one 144" hardwire infeed cable, two dual-sided power blocks and four data plate cut-outs</b>   |   |            |
| EZTB48HS   | 48"W x 5¼"D x 12¾"H   | 1,680.00   |
| EZTB60HS   | 60"W x 5¼"D x 12¾"H   | 1,772.00   |
| <b>Then Order (2) Adders include two dual-sided power blocks and four data plate cutouts</b>                                 |   |            |
| EZTB48HA   | 48"W x 5¼"D x 12¾"H   | 1,501.00   |
| EZTB60HA   | 60"W x 5¼"D x 12¾"H   | 1,601.00   |
| <b>And Order (1) Connector module to fill center space when using three beltways with 120° tops</b>                          |   |            |
| EZOTCONN   | 2½" x 5¼" x 2½" x 5¼" x 2½" x 5¼" x 8½"H (TFL color options)  | 462.00     |
| EZSCL37  | Cladding - to use with beltways to go from top of beltway to floor between end legs. Order three for each pod if desired as an option | 166.00     |

PRODUCTIVITY AREA (STORAGE CABINETS WITH BOOKSHELF) 

- Ideal for back-to-back end-of-run applications.
- A la carte area by selecting the surface (no legs), undersurface cabinet option and end-cabinet filler bookshelf (if space permits)
- Each rectangular top surface includes two Bridge Brackets and two L-Brackets
- Surfaces overhang lower cabinet by 6" to allow for cable management
- e5 Productivity work surfaces are available in HPL options. Add H at the end of the model number, i.e. EZR48H and add \$50 to the list price

**BUILD-AN-END**

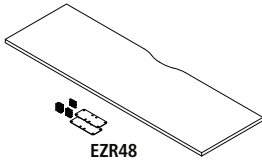

| Model No. | Description – Rectangular Top Surface          | Dimensions  | List Price |
|-----------|--|-------------|------------|
| EZR48     | For (2) 24"D Back-to-Back Tables               | 48"W x 24"D | 450.00     |
| EZR52     | For (2) 24"D Back-to-Back Tables with Beltway  | 52"W x 24"D | 471.00     |
| EZR53     | For (2) 24"D Back-to-Back Tables with Techwall | 53"W x 24"D | 493.00     |
| EZR60     | For (2) 30"D Back-to-Back Tables               | 60"W x 24"D | 471.00     |
| EZR64     | For (2) 30"D Back-to-Back Tables with Beltway  | 64"W x 24"D | 493.00     |
| EZR65     | For (2) 30"D Back-to-Back Tables with Techwall | 65"W x 24"D | 515.00     |
| EZR72     | For (2) 36"D Back-to-Back Tables               | 72"W x 24"D | 493.00     |
| EZR76     | For (2) 36"D Back-to-Back Tables with Beltway  | 76"W x 24"D | 515.00     |
| EZR77     | For (2) 36"D Back-to-Back Tables with Techwall | 77"W x 24"D | 535.00     |

| Model No.  | Description   | Dimensions          | List Price |
|------------|---|---------------------|------------|
| EZ3628FFNT | Double Lateral File Drawer, NO TOP                  | 36"W x 18"D x 28½"H | 1,497.00   |
| EZ3628FNT  | Open Upper Lever, Lateral File Drawer Lower, NO TOP | 36"W x 18"D x 28½"H | 1,265.00   |
| EZ3628NT   | 2 Shelf Bookcase, NO TOP                            | 36"W x 18"D x 28½"H | 868.00     |
| EZ3628LNT  | Laminate Hinged Doors, NO TOP                       | 36"W x 18"D x 28½"H | 1,062.00   |

**END CABINET FILLER BOOK SHELF** 

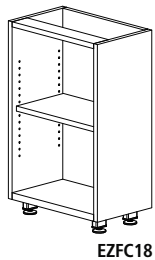

| Model No. | Description  | Dimensions          | List Price |
|-----------|--|---------------------|------------|
| EZFC18    | 1 Adjustable 9½"D Shelf, Foot Kit, Mounting Screws<br>Filler Shelf | 18"W x 11"D x 28½"H | 577.00     |

NOTE: Top and Storage Cabinets must be ordered separately.  
Two End Cabinet Filler Shelves may be required.

**MEETING END** 

- Includes surface size of your choice, (1) 3 x 3" Leg with adjustable glide, (2) Bridge Brackets and (2) L-Brackets
- e5 meeting ends are available in HPL options. Add "H" to the end of the model number, i.e. EZHR48H and add \$50 to the list price, see page 40 for edge options

| Model No. | Description – Half Round Table Kits             | Dimensions   | List Price |
|-----------|---|--------------|------------|
| EZHR48    | For (2) 24"D Back-to-Back Tables                | 48" Diameter | 729.00     |
| EZHR52    | For (2) 24"D Back-to-Back Tables with Beltway   | 52" Diameter | 750.00     |
| EZHR53    | For (2) 24"D Back-to-Back Tables with Powerwall | 53" Diameter | 783.00     |
| EZHR60    | For (2) 30"D Back-to-Back Tables                | 60" Diameter | 804.00     |
| EZHR64    | For (2) 30"D Back-to-Back Tables with Beltway   | 64" Diameter | 826.00     |
| EZHR65    | For (2) 30"D Back-to-Back Tables with Powerwall | 65" Diameter | 879.00     |
| EZHR72    | For (2) 36"D Back-to-Back Tables                | 72" Diameter | 858.00     |
| EZHR76    | For (2) 36"D Back-to-Back Tables with Beltway   | 76" Diameter | 879.00     |
| EZHR77    | For (2) 36"D Back-to-Back Tables with Powerwall | 77" Diameter | 911.00     |

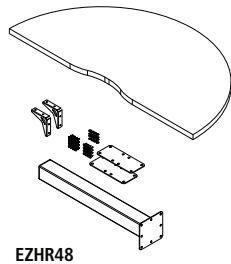

**e5™ ABOVE SURFACE ACRYLIC PRIVACY SCREENS** 

- Stylish frosted acrylic screens with flame polished edges to give the appearance of glass
- Standard Green Crystal Ice Acrylic/frosted on both sides. No color specification required
- Painted steel brackets are available in White, Silver or Black. Specify paint finish color
- Screens are meant to be space dividers or used for limited privacy – not sound absorbing
- To specify, choose panel that is 6" shorter than work surface. (For example, 60" W surface – order EZAPP54 (54"W))

**Leg Colors**

- White - G5
- Tech Silver - HK5
- Black - S5

**ACRYLIC PRIVACY PANELS – TABLE TOP MOUNTED OPTION (ATTACHES UNDERNEATH SURFACE)** 

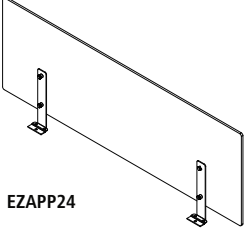

| Model No. | Dimensions               | List Price |
|-----------|--------------------------|------------|
| EZAPP18   | 18"W x 3/16"D x 12 1/2"H | 278.00     |
| EZAPP24   | 24"W x 3/16"D x 12 1/2"H | 300.00     |
| EZAPP30   | 30"W x 3/16"D x 12 1/2"H | 320.00     |
| EZAPP36   | 36"W x 3/16"D x 12 1/2"H | 332.00     |
| EZAPP42   | 42"W x 3/16"D x 12 1/2"H | 353.00     |
| EZAPP48   | 48"W x 3/16"D x 12 1/2"H | 375.00     |
| EZAPP54   | 54"W x 3/16"D x 12 1/2"H | 407.00     |
| EZAPP60   | 60"W x 3/16"D x 12 1/2"H | 428.00     |
| EZAPP66   | 66"W x 3/16"D x 12 1/2"H | 460.00     |

**ACRYLIC PRIVACY PANELS – TABLE/BELTWAY/CABINET MOUNTED OPTION (ATTACHES TO TOP OF SURFACE)** 

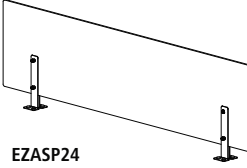

| Model No. | Dimensions               | List Price |
|-----------|--------------------------|------------|
| EZASP24   | 24"W x 3/16"D x 12 1/2"H | 300.00     |
| EZASP30   | 30"W x 3/16"D x 12 1/2"H | 320.00     |
| EZASP36   | 36"W x 3/16"D x 12 1/2"H | 332.00     |
| EZASP42   | 42"W x 3/16"D x 12 1/2"H | 353.00     |
| EZASP48   | 48"W x 3/16"D x 12 1/2"H | 375.00     |
| EZASP54   | 54"W x 3/16"D x 12 1/2"H | 407.00     |
| EZASP60   | 60"W x 3/16"D x 12 1/2"H | 428.00     |
| EZASP66   | 66"W x 3/16"D x 12 1/2"H | 460.00     |

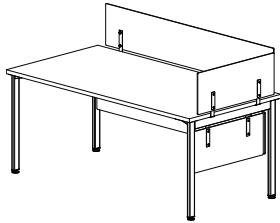

**SIDE SURFACE SUPPORT CHANNELS / WIRE MANAGEMENT** 

| Model No. | Description       | List Price |
|-----------|-------------------|------------|
| EZWC17    | For 24"D Surfaces | 88.00      |
| EZWC23    | For 30"D Surfaces | 91.00      |
| EZWC29    | For 36"D Surfaces | 93.00      |

**SIDE SURFACE MODESTY PANELS – ACRYLIC\*** 

| Model No. | Description       | Dimensions               | List Price |
|-----------|-------------------|--------------------------|------------|
| EZMAP16   | For 24"D Surfaces | 16"W x 3/16"D x 12 1/2"H | 267.00     |
| EZMAP22   | For 30"D Surfaces | 22"W x 3/16"D x 12 1/2"H | 320.00     |
| EZMAP28   | For 36"D Surfaces | 28"W x 3/16"D x 12 1/2"H | 332.00     |

\* Side Surface Support Channel required for Modesty Panel installation.

**SIDE SURFACE MODESTY PANELS – LAMINATE\*** 

| Model No. | Description       | Dimensions                  | List Price |
|-----------|-------------------|-----------------------------|------------|
| EZMLP16   | For 24"D Surfaces | 15 3/4"W x 1/2"D x 11 7/8"H | 64.00      |
| EZMLP22   | For 30"D Surfaces | 21 3/4"W x 1/2"D x 11 7/8"H | 70.00      |
| EZMLP28   | For 36"D Surfaces | 27 3/4"W x 1/2"D x 11 7/8"H | 74.00      |

\* Side Surface Support Channel required for Modesty Panel installation.

**SIDE SURFACE ACRYLIC PRIVACY SCREENS – ABOVE SURFACE (MOUNTS UNDERNEATH SURFACE)** 

| Model No. | Description       | Dimensions               | List Price |
|-----------|-------------------|--------------------------|------------|
| EZAPP18   | For 24"D Surfaces | 18"W x 3/16"D x 12 1/2"H | 278.00     |
| EZAPP24   | For 30"D Surfaces | 24"W x 3/16"D x 12 1/2"H | 300.00     |
| EZAPP30   | For 36"D Surfaces | 30"W x 3/16"D x 12 1/2"H | 320.00     |

**e5™ ABOVE SURFACE FABRIC TACK PANELS** 

- Space Divider (privacy) and functional tack board in one
- Overall panel height with bracket is 12 1/2" or 18 1/2". Brackets/hardware included
- Painted steel brackets are available in White-G5, Silver-HK5 or Black-S5. Specify paint finish color
- Select fabric from Guilford of Maine panel fabric. Fabrics listed in Corporate Color Program are standard, any other Guilford panel fabric is considered premier
- Tack Panel mounts on top of surface (tables, beltways, cabinets, etc.)
- To specify, choose panel that is 6" shorter than worksurface

| Model No. | Description                              | Dimensions  | List Price | (+P) List Price |
|-----------|--|-------------|------------|-----------------|
| EZTP2412  | e5 Above Surface Fabric Tack Panels 12"H | 24"W x 12"H | 375.00     | 482.00          |
| EZTP3012  | e5 Above Surface Fabric Tack Panels 12"H | 30"W x 12"H | 407.00     | 515.00          |
| EZTP3612  | e5 Above Surface Fabric Tack Panels 12"H | 36"W x 12"H | 439.00     | 546.00          |
| EZTP4212  | e5 Above Surface Fabric Tack Panels 12"H | 42"W x 12"H | 493.00     | 600.00          |
| EZTP4812  | e5 Above Surface Fabric Tack Panels 12"H | 48"W x 12"H | 525.00     | 633.00          |
| EZTP5412  | e5 Above Surface Fabric Tack Panels 12"H | 54"W x 12"H | 546.00     | 653.00          |
| EZTP6012  | e5 Above Surface Fabric Tack Panels 12"H | 60"W x 12"H | 578.00     | 686.00          |
| EZTP6612  | e5 Above Surface Fabric Tack Panels 12"H | 66"W x 12"H | 621.00     | 729.00          |
| EZTP2418  | e5 Above Surface Fabric Tack Panels 18"H | 24"W x 18"H | 482.00     | 589.00          |
| EZTP3018  | e5 Above Surface Fabric Tack Panels 18"H | 30"W x 18"H | 515.00     | 621.00          |
| EZTP3618  | e5 Above Surface Fabric Tack Panels 18"H | 36"W x 18"H | 546.00     | 653.00          |
| EZTP4218  | e5 Above Surface Fabric Tack Panels 18"H | 42"W x 18"H | 600.00     | 708.00          |
| EZTP4818  | e5 Above Surface Fabric Tack Panels 18"H | 48"W x 18"H | 633.00     | 739.00          |
| EZTP5418  | e5 Above Surface Fabric Tack Panels 18"H | 54"W x 18"H | 653.00     | 761.00          |
| EZTP6018  | e5 Above Surface Fabric Tack Panels 18"H | 60"W x 18"H | 686.00     | 793.00          |
| EZTP6618  | e5 Above Surface Fabric Tack Panels 18"H | 66"W x 18"H | 729.00     | 836.00          |

NOTE: Guilford of Maine panel fabric. Upholstery fabric not warranted. List price reflects Guilford of Maine standard panel fabric. If an alternative or premier line of fabric is selected, add suffix "P" to Model No. (Example: EZTP2412P) and use the (+P) column price above. Contact Customer Care for upcharge and lead time.

- Legs available in White-G5, Black-HK5 or Silver-S5
- Matching PVC edgbanding
- A variety of widths and internal configurations are available in the choice of 6 standard Thermally Fused Laminates

Laminate Colors

- Biltmore Cherry - LCRM
- Cocoa - 5AGX
- Summer Suede - 5AGY
- White - 5AGZ
- Walnut - 5AHA
- Raven - 5AHB

e5™ LAYERED HEIGHT STORAGE CABINETS 

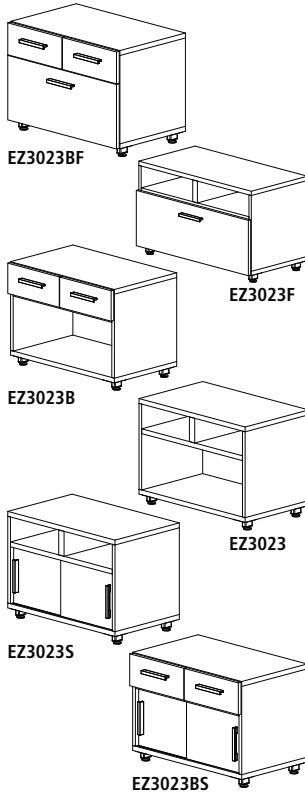

| Model No. | Upper Level     | Lower Level            | Dimensions          | Weight | List Price |
|-----------|-----------------|------------------------|---------------------|--------|------------|
| EZ3023BF  | 2 Box Drawers   | 1 Lateral File Drawer  | 30"W x 18"D x 21¾"H | 136    | 1,271.00   |
| EZ3623BF  | 2 Box Drawers   | 1 Lateral File Drawer  | 36"W x 18"D x 21¾"H | 144    | 1,391.00   |
| EZ3023F   | Divided Opening | 1 Lateral File Drawer  | 30"W x 18"D x 21¾"H | 124    | 1,023.00   |
| EZ3623F   | Divided Opening | 1 Lateral File Drawer  | 36"W x 18"D x 21¾"H | 136    | 1,110.00   |
| EZ3023B   | 2 Box Drawers   | Open                   | 30"W x 18"D x 21¾"H | 84     | 971.00     |
| EZ3623B   | 2 Box Drawers   | Open                   | 36"W x 18"D x 21¾"H | 88     | 1,051.00   |
| EZ4223B   | 2 Box Drawers   | Open                   | 42"W x 18"D x 21¾"H | 92     | 1,077.00   |
| EZ4823B   | 2 Box Drawers   | Open                   | 48"W x 18"D x 21¾"H | 96     | 1,104.00   |
| EZ3023    | Divided Open    | Open                   | 30"W x 18"D x 21¾"H | 53     | 705.00     |
| EZ3623    | Divided Open    | Open                   | 36"W x 18"D x 21¾"H | 55     | 784.00     |
| EZ4223    | Divided Open    | Open                   | 42"W x 18"D x 21¾"H | 57     | 801.00     |
| EZ4823    | Divided Open    | Open                   | 48"W x 18"D x 21¾"H | 59     | 828.00     |
| EZ3023S   | Divided Open    | Sliding Laminate Doors | 30"W x 18"D x 21¾"H | 58     | 863.00     |
| EZ3623S   | Divided Open    | Sliding Laminate Doors | 36"W x 18"D x 21¾"H | 60     | 948.00     |
| EZ4223S   | Divided Open    | Sliding Laminate Doors | 42"W x 18"D x 21¾"H | 62     | 971.00     |
| EZ4823S   | Divided Open    | Sliding Laminate Doors | 48"W x 18"D x 21¾"H | 64     | 997.00     |
| EZ3023BS  | 2 Box Drawers   | Sliding Laminate Doors | 30"W x 18"D x 21¾"H | 87     | 1,126.00   |
| EZ3623BS  | 2 Box Drawers   | Sliding Laminate Doors | 36"W x 18"D x 21¾"H | 91     | 1,202.00   |
| EZ4223BS  | 2 Box Drawers   | Sliding Laminate Doors | 42"W x 18"D x 21¾"H | 95     | 1,229.00   |
| EZ4823BS  | 2 Box Drawers   | Sliding Laminate Doors | 48"W x 18"D x 21¾"H | 99     | 1,256.00   |

BELTWAY MOUNTING KIT FOR BETWEEN LOWER STORAGE CABINETS 

- Utilize existing components into a new configuration and finish the look with a beltway mounting kit
- Includes mounting brackets and cladding pieces (order 1 kit per beltway)

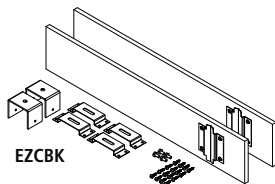

| Model No. | Description       | List Price |
|-----------|-------------------|------------|
| EZCBK     | One size fits all | 320.00     |

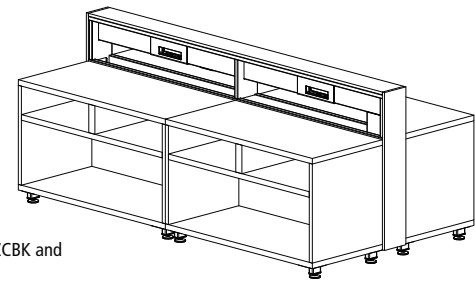

Lower cabinets shown utilizing EZCBK and EZTB60PS.

OPTIONAL FABRIC SEAT CUSHIONS 

- Seat cushions are attached to cabinets with Velcro® strips (included)

For fabric choices on cushions refer to pages 144-145 for Safco standard options. Prices as quoted below. COM Fabric Program available. See separate order form on our website.

| FABRIC GRADE SELECTIONS LIST PRICES |   |        |        |        |
|-------------------------------------|---|--------|--------|--------|
| Model No.                           | Dimensions                              | 02     | 03     | COM    |
| EZSC15                              | 15½"W x 23"D x 2"H (Mobile Ped Cushion) | 284.00 | 313.00 | 313.00 |
| EZSC24                              | 23"W x 17"D x 2"H (Mobile Ped Cushion)  | 284.00 | 313.00 | 313.00 |
| EZSC30                              | 29"W x 17"D x 2"H (Mobile Ped Cushion)  | 305.00 | 335.00 | 335.00 |
| EZSC36                              | 35"W x 17"D x 2"H (Mobile Ped Cushion)  | 335.00 | 369.00 | 369.00 |
| EZSC42                              | 41"W x 17"D x 2"H (Mobile Ped Cushion)  | 367.00 | 404.00 | 404.00 |
| EZSC48                              | 47"W x 17"D x 2"H (Mobile Ped Cushion)  | 387.00 | 426.00 | 426.00 |

Office Suites  
Seating  
Tables  
Desks  
Meeting Essentials  
Personal Organization  
Ergonomics  
High Density Storage  
Storage & Filing  
Facilities  
Technology Furniture  
Art & Engineering



# e5™ Surface-Height Storage Cabinets

## e5™ SURFACE-HEIGHT STORAGE CABINETS



- Cabinets are available in a variety of widths and internal configurations in a choice of six Thermally Fused Laminates
- Storage cabinets are made of 1 1/8" TFL tops, bottoms and shelves and 3/4" TFL sides and finished backs
- Cabinets ship assembled; pulls and legs are field installed
- Legs available in White-G5, Black-HK5 or Silver-S5
- EZ3628FF files ship with randomly keyed locks as standard; field installed replacement cores and keys can be ordered at an additional cost
- Matching PVC edgebanding
- Single drawer laterals do NOT have locks

### Laminate Colors

- Biltmore Cherry - LCRM
- Cocoa - 5AGX
- Summer Suede - 5AGY
- White - 5AGZ
- Walnut - 5AHA
- Raven - 5AHB

### Leg Colors

- White - G5
- Tech Silver - HK5
- Black - S5



EZ3628FF

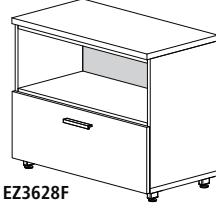

EZ3628F

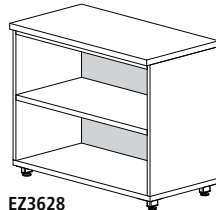

EZ3628

| Model No. | Upper Level           | Lower Level                   | Dimensions              | Weight | List Price |
|-----------|-----------------------|-------------------------------|-------------------------|--------|------------|
| EZ3628FF  | Lateral File Drawer   | Lateral File Drawer           | 36"W x 18"D x 29 1/2" H | 240    | 1,712.00   |
| EZ3628F   | Open                  | Lateral File Drawer           | 36"W x 18"D x 29 1/2" H | 205    | 1,372.00   |
| EZ3628    | Open                  | Open without Doors (Bookcase) | 36"W x 18"D x 29 1/2" H | 85     | 1,081.00   |
| EZ3628L   | Laminate Hinged Doors | Laminate Hinged Doors         | 36"W x 18"D x 29 1/2" H | 105    | 1,270.00   |

### Surface-Height Storage Cabinets (Two 36" Open Cabinets with Common 1 1/8" Top)

|        |   |   |                           |     |          |
|--------|---|---|---------------------------|-----|----------|
| EZ7228 | - | - | 72" W x 18" D x 29 1/2" H | 173 | 1,942.00 |
|--------|---|---|---------------------------|-----|----------|

### Surface-Height Storage Cabinets – Hinged Laminate Doors (Two 36" Cabinets with Common 1 1/8" Top)

|         |                                     |  |                           |     |          |
|---------|-------------------------------------|--|---------------------------|-----|----------|
| EZ7228L | (Includes 1 Fixed Horizontal Shelf) |  | 72" W x 18" D x 29 1/2" H | 197 | 2,362.00 |
|---------|-------------------------------------|--|---------------------------|-----|----------|

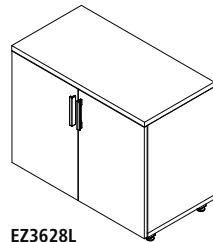

EZ3628L

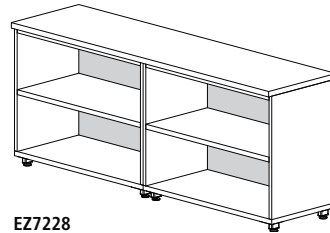

EZ7228

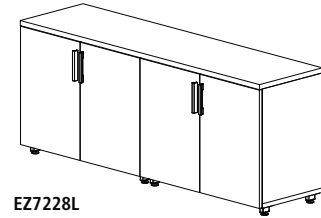

EZ7228L

## e5™ COUNTER-HEIGHT STORAGE CABINETS

- Cabinets ship assembled; pulls and legs are field installed
- Legs are available in White-G5, Black-HK5 or Silver-S5 finish
- Tops are made of 1 1/8" TFL ( 6 color options) or HPL tops in a variety of colors

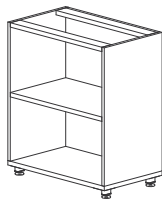

EZ3036NT

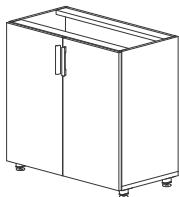

EZ3636LNT

| Model No.                               | Descriptions                     | Dimensions              | Weight | List     |
|---|----------------------------------|-------------------------|--------|----------|
| <b>Cabinets:</b>                        |                                  |                         |        |          |
| Tops NOT included; options on next page |                                  |                         |        |          |
| EZ3036NT                                | Open with shelf, no Doors        | 30"W x 18"D x 34 7/8" H | 80     | 998.00   |
| EZ3636NT                                | Open with shelf, no Doors        | 36"W x 18"D x 34 7/8" H | 92     | 1,050.00 |
| EZ3036LNT                               | Laminate Hinged Doors with Shelf | 30"W x 18"D x 34 7/8" H | 102    | 1,281.00 |
| EZ3636LNT                               | Laminate Hinged Doors with Shelf | 36"W x 18"D x 34 7/8" H | 117    | 1,332.00 |

e5™ COUNTER-HEIGHT STORAGE CABINETS

| Model No.   | Descriptions  | Dimensions               | Weight | List Price |
|-------------|---|--------------------------|--------|------------|
| <b>Tops</b> |   |                          |        |            |
| EZT3019     | TFL Top for 30" W cabinet                               | 30" W x 19" D x 1 1/8" H | 20     | 291.00     |
| EZT3019H    | HPL Top for 30" W cabinet                               | 30" W x 19" D x 1 1/8" H | 20     | 342.00     |
| EZT3619     | TFL Top for 36" W cabinet                               | 36" W x 19" D x 1 1/8" H | 24     | 303.00     |
| EZT3619H    | HPL Top for 36" W cabinet                               | 36" W x 19" D x 1 1/8" H | 24     | 354.00     |
| EZT6019     | TFL Common Top for (two) 30" W Cabinets                 | 60" W x 19" D x 1 1/8" H | 40     | 427.00     |
| EZT6019H    | HPL Common Top for (two) 30" W Cabinets                 | 60" W x 19" D x 1 1/8" H | 40     | 479.00     |
| EZT7219     | TFL Common Top for (two) 36" W Cabinets                 | 72" W x 19" D x 1 1/8" H | 47     | 485.00     |
| EZT7219H    | HPL Common Top for (two) 36" W Cabinets                 | 72" W x 19" D x 1 1/8" H | 47     | 536.00     |
| EZT9619     | TFL Common Top for combination of (two) 30" & (one) 36" | 96" W x 19" D x 1 1/8" H | 62     | 542.00     |
| EZT9619H    | HPL Common Top for combination of (two) 30" & (one) 36" | 96" W x 19" D x 1 1/8" H | 62     | 594.00     |

e5™ FREESTANDING STORAGE 

- e5 Wardrobe Storage Towers come in a choice of six Thermally Fused Laminates (TFL) with matching edgebanding
- Wardrobes and Bookcases ship assembled. Legs, pulls and shelves are field installed
- Wardrobes and Bookcases are supported by 1 7/8" high painted steel legs with adjustable glides, available in White-G5, Black-HK5 or Silver-S5
- Shelves adjust in 1" increments

Laminate Colors (TFL)

Biltmore Cherry - LCRM  
 Cocoa - 5AGX  
 Summer Suede - 5AGY  
 White - 5AGZ  
 Walnut - 5AHA  
 Raven - 5AHB

Leg Colors

White - G5  
 Tech Silver - HK5  
 Black - S5

WARDROBE STORAGE TOWERS 

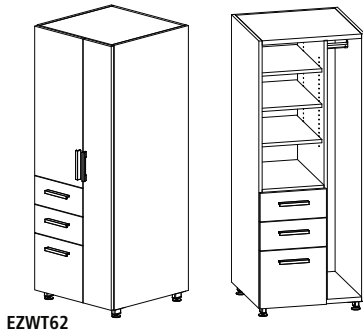

EZWT62

Interior view.

| Model No. | Description     | Dimensions                    | Weight | List Price |
|-----------|-----------------|-------------------------------|--------|------------|
| EZWT51    | 2 Shelf (left)  | 23 1/2" W x 23 1/2" D x 51" H | 231    | 2,146.00   |
| EZWT62    | 3 Shelf (left)  | 23 1/2" W x 23 1/2" D x 62" H | 268    | 2,217.00   |
| EZWT51R   | 2 Shelf (right) | 23 1/2" W x 23 1/2" D x 51" H | 231    | 2,146.00   |
| EZWT62R   | 3 Shelf (right) | 23 1/2" W x 23 1/2" D x 62" H | 268    | 2,217.00   |

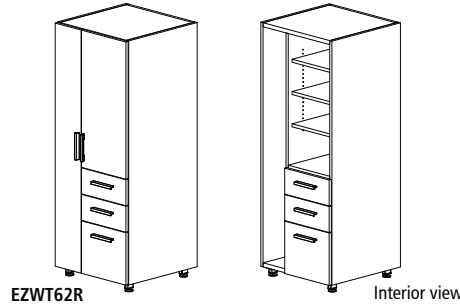

EZWT62R

Interior view.

COMPACT WARDROBE TOWERS 

- Right-swing door on 1/2 Door, 1/2 open. Left swing door on 1/2 high

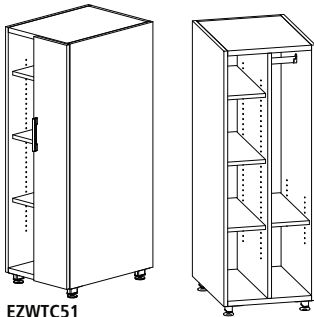

EZWTC51

Interior view.

| Model No. | Description           | Dimensions                    | Weight | List Price |
|-----------|-----------------------|-------------------------------|--------|------------|
| EZWTC51   | 1/2 Door, 1/2 Open    | 15" W x 23 1/2" D x 51" H     | 150    | 1,524.00   |
| EZWTC62   | 1/2 Door, 1/2 Open    | 15" W x 23 1/2" D x 62" H     | 175    | 1,585.00   |
| EZWT1562  | 1/2 High Wardrobe/BBF | 15 1/2" W x 23 1/2" D x 62" H | 200    | 1,878.00   |

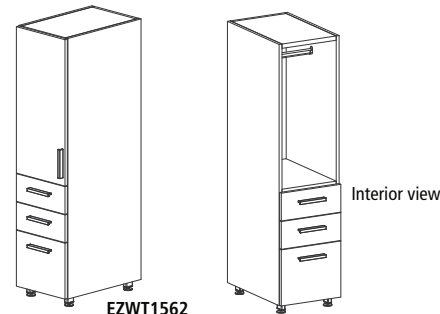

EZWT1562

Interior view.

**BOOKCASES**

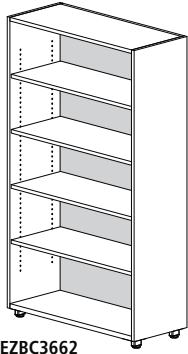

EZBC3662

- Bookcases are 36" wide in 3 heights with adjustable (on 1" increments) shelves except for fixed base shelf
- Case comes preassembled
- Leveling glides have 1" adjustment

| Model No. | Description | Dimensions          | Weight | List Price |
|-----------|-------------|---------------------|--------|------------|
| EZBC3629  | 2 Shelf     | 36"W x 15"D x 29½"H | 75     | 731.00     |
| EZBC3651  | 4 Shelf     | 36"W x 15"D x 51"H  | 105    | 1,070.00   |
| EZBC3662  | 5 Shelf     | 36"W x 15"D x 62"H  | 116    | 1,145.00   |

**BOOKCASE TOWERS (PEDESTAL OPTIONS)**

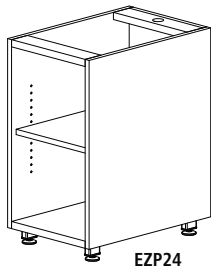

EYP24

- Adjustable shelf in 1" increments

| Model No. | Description                    | Dimensions           | Weight | List Price |
|-----------|--------------------------------|----------------------|--------|------------|
| EYP24     | 24" Deep Open/Open Ped, no top | 15½"W x 24"D x 28½"H | 75     | 604.00     |
| EYP30     | 30" Deep Open/Open Ped, no top | 15½"W x 30"D x 28½"H | 80     | 692.00     |
| EYP36     | 36" Deep Open/Open Ped, no top | 15½"W x 36"D x 28½"H | 85     | 752.00     |

NOTE: Open pedestal with 1 shelf and wire cutout.

|          |                      |                      |     |          |
|----------|----------------------|----------------------|-----|----------|
| EYP24BBF | 24" Deep BBF, no top | 15½"W x 24"D x 28½"H | 96  | 901.00   |
| EYP30BBF | 30" Deep BBF, no top | 15½"W x 30"D x 28½"H | 105 | 956.00   |
| EYP36BBF | 36" Deep BBF, no top | 15½"W x 36"D x 28½"H | 115 | 1,028.00 |

|         |                     |                      |     |        |
|---------|---------------------|----------------------|-----|--------|
| EYP24FF | 24" Deep FF, no top | 15½"W x 24"D x 28½"H | 82  | 853.00 |
| EYP30FF | 30" Deep FF, no top | 15½"W x 30"D x 28½"H | 92  | 909.00 |
| EYP36FF | 36" Deep FF, no top | 15½"W x 36"D x 28½"H | 102 | 954.00 |

NOTE: Open pedestal with 1 shelf and wire cutout.

**BOOKCASE TOWERS (BOOKCASE ADDER)**

- Select a bookcase size/height (Attach bookcase to pedestal at install – hardware included in ped)
- Adjustable shelves in 1" increments (2 shelves on 62", 1 on 52")
- Available in either 51" or 62" overall height when mounted on pedestal
- Shelf has 13 positions

| Model No. | Description                         | Dimensions           | Weight | List Price |
|-----------|-------------------------------------|----------------------|--------|------------|
| EZBC2423  | 2 Shelf Bookcase for above 24"D Ped | 24"W x 15½"D x 23¼"H | 75     | 535.00     |
| EZBC3023  | 2 Shelf Bookcase for above 30"D Ped | 30"W x 15½"D x 23¼"H | 80     | 557.00     |
| EZBC3623  | 2 Shelf Bookcase for above 36"D Ped | 36"W x 15½"D x 23¼"H | 85     | 568.00     |

NOTE: Not for use as a stand-alone bookcase.  
51" overall height when stacked on pedestal.

|          |                                     |                      |     |        |
|----------|-------------------------------------|----------------------|-----|--------|
| EZBC2434 | 3 Shelf Bookcase for above 24"D Ped | 24"W x 15½"D x 34¼"H | 95  | 671.00 |
| EZBC3034 | 3 Shelf Bookcase for above 30"D Ped | 30"W x 15½"D x 34¼"H | 105 | 724.00 |
| EZBC3634 | 3 Shelf Bookcase for above 36"D Ped | 36"W x 15½"D x 34¼"H | 115 | 825.00 |

NOTE: 62" overall height when stacked on pedestal.

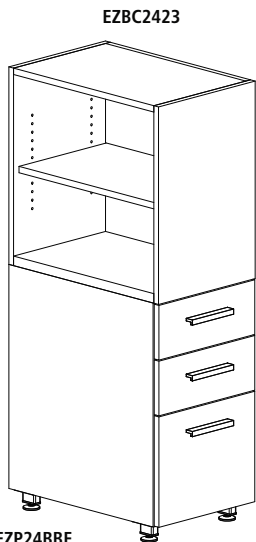

EYP24BBF

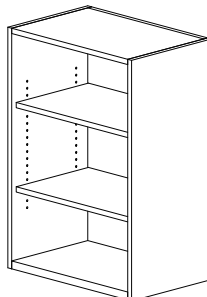

EZBC2434

Use a Mobile Pedestal for storage and as convenient guest seating

- Available in the six TFL colors with matching edge banding
- Pedestals are shipped assembled; pulls and casters are field installed
- Drawer pull is available in Silver only
- Pedestals come with one Silver lock, keyed randomly. Additional keys and cores are available for additional fee

**Laminate Colors (TFL)**

Biltmore Cherry - LCRM

Cocoa - 5AGX

Summer Suede - 5AGY

White - 5AGZ

Walnut - 5AHA

Raven - 5AHB

**MOBILE PEDESTAL** 



| Model No. | Description     | Dimensions          | Weight | List Price |
|-----------|-----------------|---------------------|--------|------------|
| EZPM24BF  | Mobile Pedestal | 15½"W x 24"D x 23"H | 82     | 637.00     |

**OPTIONAL FABRIC SEAT CUSHIONS** 

- Optional Seat Cushions are attached to cabinets with Velcro® strips that are included with the cushion

For fabric choices on cushions refer to pages 144-145 for Safco standard options. Prices as quoted below. COM Fabric Program available. See separate order form on our website.

Cushion shown with Mobile Pedestal.

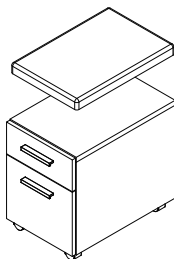

| FABRIC GRADE SELECTIONS LIST PRICES |   |        |        |        |
|-------------------------------------|---|--------|--------|--------|
| Model No.                           | Dimensions                              | 02     | 03     | COM    |
| EZSC15                              | 15½"W x 23"D x 2"H (Mobile Ped Cushion) | 284.00 | 313.00 | 313.00 |

**e5™ REPLACEMENT LOCK CORES** 

- Allows pedestals and storage cabinets to be keyed random, or alike
- Master keys available in brass only
- Field replacement only
- Replacement cores in Satin Nickel finish
- Must purchase a core removal tool to change lock cores
- Additional replacement core with keys available upon request

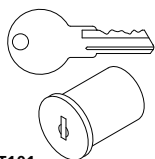

EZKT101

| Model No. | Description                | List Price |
|-----------|----------------------------|------------|
| EZKT101   | Replacement Core with Keys | 23.00      |
| EZKT102   | Replacement Core with Keys | 23.00      |
| EZKT103   | Replacement Core with Keys | 23.00      |
| EZKT104   | Replacement Core with Keys | 23.00      |
| EZMK      | Master Key                 | 23.00      |
| EZCRT     | Core Removal Tool          | 23.00      |

## e5™ OVERHEAD STORAGE CABINETS

- Overhead Storage Cabinets available in one of six e5 TFL colors
- Overhead Storage Cabinets shipped assembled with doors attached
- Overhead Cabinets can be wall mounted (cabinets 42" and wider include cleats), mounted on Technology Beltway/Wall (cabinets 36" and narrower include beltway brackets), or on corner supports
- Tack Panels and Dry Erase boards (see Accessories page 79) available to fit on the reverse side of the 24", 30" and 36" units in open plan settings
- 24", 30" and 36" cabinets include pilot holes / brackets for mounting to Beltways and Tech Walls
- Cabinets 42" H and above automatically include cleats for wall mounting. For cabinets 24", 30" and 36" order Wall Cleat (WC) model # noted below (same price)
- Colored Glass Hinged Door option also available in Azure-GAZB, Black-GBLK, Silk-GSKB, Willow-GWLY

### Laminate Colors (TFL)

- Biltmore Cherry - LCRM
- Cocoa - 5AGX
- Summer Suede - 5AGY
- White - 5AGZ
- Walnut - 5AHA
- Raven - 5AHB

| Model No. | Description                       | With Wall Cleats (WC) | Dimensions          | Weight | List Price |
|-----------|-----------------------------------|-----------------------|---------------------|--------|------------|
| EZH24     | Open/No Doors                     | EZH24WC               | 24"W x 15"D x 15"H  | 34     | 402.00     |
| EZH30     | Open/No Doors                     | EZH30WC               | 30"W x 15"D x 15"H  | 47     | 438.00     |
| EZH36     | Open/No Doors                     | EZH36WC               | 36"W x 15"D x 15"H  | 78     | 477.00     |
| EZSA24    | Open/No Doors/2 Sided             |                       | 24"W x 15"D x 15"H  | 47     | 454.00     |
| EZSA30    | Open/No Doors/2 Sided             |                       | 30"W x 15"D x 15"H  | 50     | 473.00     |
| EZSA36    | Open/No Doors/2 Sided             |                       | 36"W x 15"D x 15"H  | 81     | 544.00     |
| EZH24S    | Open/2 Sliding/Beltway Mount Kit  | EZH24SWC              | 24"W x 15"D x 15"H  | 49     | 535.00     |
| EZH30S    | Open/2 Sliding/Beltway Mount Kit  | EZH30SWC              | 30"W x 15"D x 15"H  | 52     | 643.00     |
| EZH36S    | Open/2 Sliding/Beltway Mount Kit  | EZH36SWC              | 36"W x 15"D x 15"H  | 83     | 750.00     |
| EZSA24S   | Dual-Sided/1 Sliding on each side |                       | 24"W x 15"D x 15"H  | 50     | 535.00     |
| EZSA30S   | Dual-Sided/1 Sliding on each side |                       | 30"W x 15"D x 15"H  | 53     | 696.00     |
| EZSA36S   | Dual-Sided/1 Sliding on each side |                       | 36"W x 15"D x 15"H  | 84     | 804.00     |
| EZH30L    | 2 Laminate Hinged Doors           | EZH30LWC              | 30"W x 15¾"D x 15"H | 60     | 588.00     |
| EZH36L    | 2 Laminate Hinged Doors           | EZH36LWC              | 36"W x 15¾"D x 15"H | 102    | 649.00     |
| EZH42L    | 2 Laminate Hinged Doors           |                       | 42"W x 15¾"D x 15"H | 134    | 694.00     |
| EZH48L    | 2 Laminate Hinged Doors           |                       | 48"W x 15¾"D x 15"H | 54     | 710.00     |
| EZH60L    | 4 Laminate Hinged Doors           |                       | 60"W x 15¾"D x 15"H | 70     | 1,028.00   |
| EZH72L    | 4 Laminate Hinged Doors           |                       | 72"W x 15¾"D x 15"H | 114    | 1,073.00   |
| EZH78L    | 4 Laminate Hinged Doors           |                       | 78"W x 15¾"D x 15"H | 134    | 1,095.00   |
| EZH30F    | 2 Frosted Glass Hinged Doors      | EZH30FWC              | 30"W x 15¾"D x 15"H | 55     | 770.00     |
| EZH36F    | 2 Frosted Glass Hinged Doors      | EZH36FWC              | 36"W x 15¾"D x 15"H | 90     | 812.00     |
| EZH42F    | 2 Frosted Glass Hinged Doors      |                       | 42"W x 15¾"D x 15"H | 122    | 863.00     |
| EZH48F    | 2 Frosted Glass Hinged Doors      |                       | 48"W x 15¾"D x 15"H | 142    | 878.00     |
| EZH60F    | 4 Frosted Glass Hinged Doors      |                       | 60"W x 15¾"D x 15"H | 62     | 1,379.00   |
| EZH72F    | 4 Frosted Glass Hinged Doors      |                       | 72"W x 15¾"D x 15"H | 108    | 1,430.00   |
| EZH78F    | 4 Frosted Glass Hinged Doors      |                       | 78"W x 15¾"D x 15"H | 126    | 1,450.00   |

Colored Glass Door Options include: Azure, Black, Silk, Willow

|        |                              |          |                       |     |          |
|--------|------------------------------|----------|-----------------------|-----|----------|
| EZH30C | 2 Colored Glass Hinged Doors | EZH30CWC | 30"W x 15¾" D x 15" H | 55  | 873.00   |
| EZH36C | 2 Colored Glass Hinged Doors | EZH36CWC | 36"W x 15¾" D x 15" H | 90  | 915.00   |
| EZH42C | 2 Colored Glass Hinged Doors |          | 42"W x 15¾" D x 15" H | 122 | 965.00   |
| EZH48C | 2 Colored Glass Hinged Doors |          | 48"W x 15¾" D x 15" H | 142 | 981.00   |
| EZH60C | 4 Colored Glass Hinged Doors |          | 60"W x 15¾" D x 15" H | 62  | 1,585.00 |
| EZH72C | 4 Colored Glass Hinged Doors |          | 72"W x 15¾" D x 15" H | 108 | 1,635.00 |
| EZH78C | 4 Colored Glass Hinged Doors |          | 78"W x 15¾" D x 15" H | 126 | 1,656.00 |

See Accessories on page 79

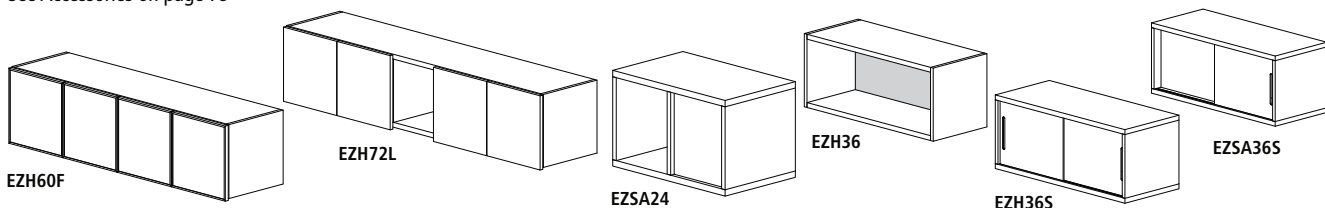

OVERHEAD CABINET SUPPORT 

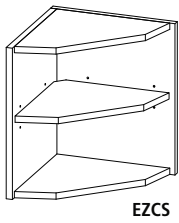

EZCS

| Model No. | Description                         | Dimensions         | Weight | List Price |
|-----------|-------------------------------------|--------------------|--------|------------|
| EZCS      | Corner Support for Overhead Cabinet | 15"W x 15"D x 18"H | 18     | 322.00     |
| EZSM18H   | Support Modules/Horizontal          | 15"W x 15"D x 18"H | 21     | 449.00     |
| EZSM18V   | Support Modules/Vertical            | 15"W x 15"D x 18"H | 21     | 449.00     |

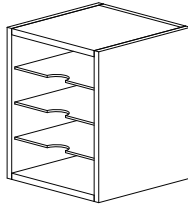

EZSM18H

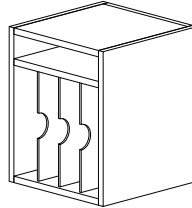

EZSM18V

OVERHEAD CENTER ACCESS MODULE 

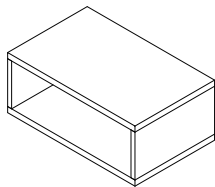

| Model No. | Description                                | Dimensions        | Weight | List Price |
|-----------|--|-------------------|--------|------------|
| EZCA24    | Passthrough used with 42"H Peninsula Table | 24"W x 15"D x 9"H | 8      | 293.00     |

e5™ POWER AND DATA MANAGEMENT 

**How to Specify:** Please refer to pre-configured Idea Starter section for examples of e5 workstations.

(Space planning is available to assist in these decisions.)

- 1. Beltways or Walls:** Based on your configuration, choose either Technology Beltways or Technology Walls. Both provide equal power/data connectivity, but work with different types of work surfaces.
- 2. Single- or 4-Circuit Power:** For configurations with only one (1) Beltway or Wall, you have the option of selecting single-circuit (plug-in) or 4-circuit (hardwired) power. Two (2) or more Beltways or Walls in a configuration require 4-circuit power for adequate power capacity. (See specifications below for power system details.)
- 3. Starters:** Choose the Beltway or Wall 'Starter' unit based on your power needs and size of work surfaces. Starters include Beltway or Wall, infeed cable (72" L plug-in for single-circuit or 144" L hardwired for 4-circuit), dual-sided power blocks with 4-outlets per side, and data plate cut-outs. (See charts below for specifics.) If selecting a plug-in (single circuit) starter, adder sections cannot be joined to it.
- 4. Adders:** Choose the Beltway or Wall 'Adder' unit(s) based on your overall configuration. Adders include Beltway or Wall, dual-sided power blocks with 4-outlets per side, 34" L connecting cable, and data plate cut-outs. (See charts below for specifics.)

- Power kits can be reconfigured at any time with no tools required
- Power kits are UL Recognized and CSA Certified
- Single-Circuit kits are rated for 20 amps. 4-Circuit, 8-Wire kits are rated for 80 amps
- It is the customer's responsibility to ensure that the use of electrical systems, including the number of receptacles on a given circuit and connection to the building's power source, be in compliance with all electrical codes. Refer to the chart below for typical power usage by common office equipment
- City of Chicago solution available. Hard wiring by an electrician required. Contact Space Planning for alternative part numbers

| TYPICAL POWER USAGE BY COMMON OFFICE EQUIPMENT |                                  |                                       |
|--|----------------------------------|---------------------------------------|
| <b>Computers</b> . . . . . AMPS                | <b>Copiers</b> . . . . . AMPS    | <b>FAX Machines</b> . . . . . AMPS    |
| Desktop . . . . . 3-5                          | Desktop . . . . . .15            | Inkjet/Thermal . . . . . 0.75         |
| Laptop . . . . . .3                            | Console . . . . . .20            | Plain Paper . . . . . .6              |
| <b>Monitors</b> . . . . . AMPS                 | Copier/Duplicator . . . . . .30  | <b>Task Lights</b> . . . . . AMPS     |
| 13" . . . . . .2                               | <b>Printers</b> . . . . . AMPS   | 36" T8 Fluorescent . . . . . 0.2/Bulb |
| 17" . . . . . .3                               | Inkjet . . . . . .0.5            | 48" T8 Fluorescent . . . . . 0.3/Bulb |
| 21" . . . . . .3                               | Laser or LED . . . . . .8        |                                       |
|  | Group Laser or LED . . . . . .15 |                                       |

NOTE: Plug-in infeed is single circuit.