

NAPOLI[®] VENEER SERIES



FAST Freight
QUICK-SHIP

The Napoli veneer desk system features Italian-influenced, sophisticated styling for business or home office. Available in two rich finishes, Napoli Furniture features AA-grade select North American hardwood veneers throughout.

Surfaces: Sierra Cherry finish on Cherry veneer, or Mahogany finish on Walnut veneer.

- Desk, Return and Extension work surfaces are 1-1/8" thick with a distinctive beveled edge.
- All veneer surfaces are protected with two coats of high-tech catalyzed lacquer.
- All models in all finishes are available on both the Quick-Ship and Fast Freight delivery programs with no quantity limitations.
- Recommended under-cabinet LED Task Light is model EZDP. Other LED Task/Desk lighting is available in the ACCESSORIES section at the end of this price list.
- All locks are keyed-alike and feature removable cores for installing "keyed-different" locks after-market.
- Silver detailing adds contemporary look to the Napoli series.

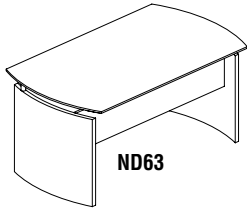
DESK



- Napoli desk surface seems to "float" on Silver supports.
- Silver modesty panel.
- Curved end panels reflect curved ends of work surface.

| Model No. | Dimensions | Wt. | List Price |
|-------------|------------------------|------|------------|
| ND63 | 63"W x 36"D x 29 1/2"H | 155# | \$1310 |
| ND72 | 72"W x 36"D x 29 1/2"H | 183# | \$1416 |

CURVED DESK RETURN WITH PENCIL-BOX-FILE PEDESTAL

- Creates L-shaped work surface when attached to desk.
- Available for right or left side of desk.
- Gang-lock features removable core.
- Supported by Return Pencil-Box-File Pedestal.
- Pedestal drawer interiors finished to match exterior veneer.
- Stands off floor on Silver legs.

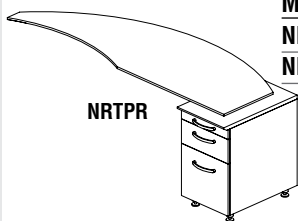

| Model No. | Description | Dimensions | Wt. | List Price |
|--------------|------------------|------------------------|------|------------|
| NRTPR | 63" Right return | 63"W x 24"D x 29 1/2"H | 123# | \$1324 |
| NRTPL | 63" Left return | 63"W x 24"D x 29 1/2"H | 123# | \$1324 |

CURVED DESK EXTENSION

- Creates conference end to Napoli desk.
- Leg includes grommets for cable management.
- Supported by Silver leg.
- Available for right or left side of desk.

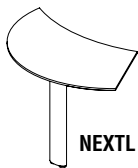

| Model No. | Description | Dimensions | Wt. | List Price |
|--------------|-----------------|------------------------|-----|------------|
| NEXTR | Right extension | 47"W x 28"D x 29 1/2"H | 51# | \$601 |
| NEXTL | Left extension | 47"W x 28"D x 29 1/2"H | 51# | \$601 |

CREDENZA

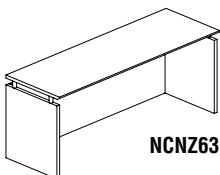

| Model No. | Dimensions | Wt. | List Price |
|---------------|------------------------|------|------------|
| NCNZ63 | 63"W x 24"D x 29 1/2"H | 133# | \$1135 |
| NCNZ72 | 72"W x 24"D x 29 1/2"H | 151# | \$1223 |

BRIDGE

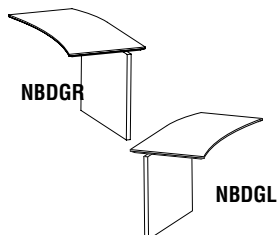

- Not free standing. Requires connection to credenza and desk.
- Features modesty panel.

| Model No. | Description | Dimensions | Wt. | List Price |
|--------------|-------------------|------------------------|-----|------------|
| NBDGR | Right Hand Bridge | 48"W x 24"D x 29 1/2"H | 68# | \$714 |
| NBDGL | Left Hand Bridge | 48"W x 24"D x 29 1/2"H | 68# | \$714 |

NAPOLI VENEER SERIES

HUTCH

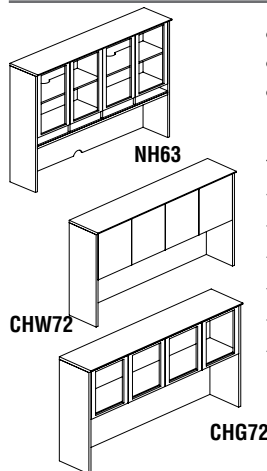

- Clear glass doors with silver frames.
- Four open compartment slots accept optional trays (See Hutch Trays).
- Provides 19 3/4"H clearance below shelf.
- Two, 12"H storage levels.
- Fully assembled.

| Model No. | Dimensions | Wt. | List Price |
|---------------------------------|----------------------------|------|------------|
| NH63 | 63"W x 15"D x 50 1/2"H | 183# | \$2439 |
| NH72 | 72"W x 15"D x 50 1/2"H | 209# | \$2584 |
| CHW63 (with Wood Doors) | 63 3/4"W x 15"D x 38 1/2"H | 160# | \$1665 |
| CHG63 (with Glass Doors) | 63 3/4"W x 15"D x 38 1/2"H | 160# | \$1665 |
| CHW72 (with Wood Doors) | 71 3/4"W x 15"D x 38 1/2"H | 172# | \$1775 |
| CHG72 (with Glass Doors) | 71 3/4"W x 15"D x 38 1/2"H | 172# | \$1775 |

NOTE: Recommended under-cabinet LED Task Light is model EZDP.
 Other LED Task/Desk lighting is available in the ACCESSORIES section at the end of this price list.

FABRIC PANELS

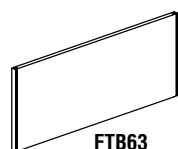

- Stocked in MIR1454 Birch Fabric.
- Other fabrics available as a special order; special orders sold in pairs.

| Model No. | Dimensions | Wt. | List Price |
|--------------|-----------------|-----|------------|
| FTB63 | 60"W x 18 1/2"H | 15# | \$493 |
| FTB72 | 69"W x 18 1/2"H | 16# | \$493 |

HUTCH TRAYS

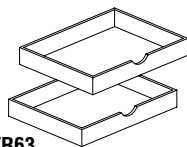

- Sold in pairs.
- Leather inlay.
- Silver.

| Model No. | Description | Dimensions | Wt. | List Price |
|---------------|----------------------|-------------------------------|-----|------------|
| NHTR63 | Hutch Trays - 63 (2) | 14 5/8"W x 12 3/4"D x 2 3/8"H | 7# | \$219 |
| NHTR72 | Hutch Trays - 72 (2) | 15 1/8"W x 12 3/4"D x 2 3/8"H | 8# | \$219 |

PEDESTALS

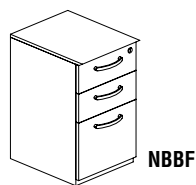

- Drawer interiors finished to match exterior veneer.
- Drawers operate smoothly using full-extension ball-bearing suspensions.
- Fits under credenzas.
- Gang-lock features removable core.
- Finished top surface.

| Model No. | Dimensions | Wt. | List Price |
|--------------------------|----------------------------|-----|------------|
| NBBF Box-Box File | 15 1/4"W x 21 1/4"D x 26"H | 80# | \$903 |
| NFF File-File | 15 1/4"W x 21 1/4"D x 26"H | 78# | \$860 |

CENTER DESK DRAWER

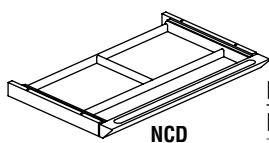

- Solid wood frame construction. Leather lined interior compartments.
- Drawer operates smoothly using full-extension ball-bearing suspension.
- Beveled front edge to match desk surface design.

| Model No. | Dimensions | Wt. | List Price |
|------------|-----------------------------|-----|------------|
| NCD | 30"W x 18"D x 2"H Assembled | 10# | \$245 |

NAPOLI VENEER SERIES

MOBILE PEDESTALS

- Choice of two styles featuring two file drawers or two box drawers and one file drawer.
- File drawers accommodate letter and legal sized hanging file folders.
- Includes counter-weight for stability when in use.
- Drawers operate smoothly using full-extension ball-bearing suspensions.
- Gang-lock features removable core enabling keyed-alike suites.
- 2" dual-hooded casters. (2 lock, 2 non-lock)

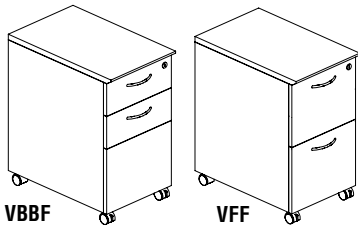

| Model No. | Description | Dimensions | Wt. | List Price |
|-----------|--------------|--------------------------------------|-----|------------|
| VBBF | Box-Box-File | 15 1/4"W x 24"D x 27 1/2"H Assembled | 92# | \$897 |
| VFF | File-File | 15 1/4"W x 24"D x 27 1/2"H Assembled | 80# | \$870 |

LATERAL FILE



- Accommodate letter and legal sized hanging file folders.
- Includes counter-weight for stability when in use.
- Gang-lock features removable core enabling keyed-alike suites.
- Drawers operate smoothly using full-extension ball-bearing suspensions.

| Model No. | Description | Dimensions | Wt. | List Price |
|-----------|-------------|----------------------------------|------|------------|
| VLF | File-File | 36"W x 19"D x 29 1/2"H Assembled | 160# | \$1573 |

WARDROBE CABINETS



- Universal Door can either hinge on either right or left.
- Interior features sliding wardrobe hanging bar.
- Includes one fixed shelf and three adjustable shelves. (1 1/4" increments)

| Model No. | Description | Dimensions | Wt. | List Price |
|-----------|----------------|------------------------|------|------------|
| VWRD | Universal Door | 23 5/8"W x 19"D x 80"H | 180# | \$1728 |

HIGH WALL CABINET WITH DOORS

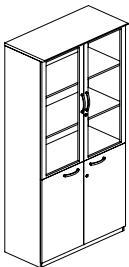

- Features glass doors with silver frame above wood doors.
- Top and bottom doors lock separately. Keyed alike.
- Includes two adjustable shelves in top section and one adjustable shelf in lower section.
- Able to stand alone or be flanked by Wardrobe Cabinets.

| Model No. | Dimensions | Wt. | List Price |
|-----------|--------------------|------|------------|
| VHC | 40"W x 19"D x 80"H | 284# | \$2749 |

68" WALL CABINET

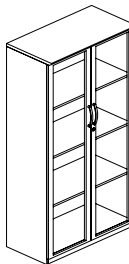

- Storage unit with choice of wood doors or glass doors.
- Includes one fixed shelf and two adjustable shelves.

| Model No. | Description | Dimensions | Wt. | List Price |
|-----------|------------------|--------------------|------|------------|
| VCG | With glass doors | 36"W x 19"D x 68"H | 253# | \$1921 |

NAPOLI VENEER SERIES

LOW WALL CABINET WITH DOORS

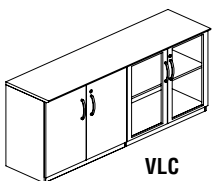

- Features a choice of wood/glass, all-wood, or all-glass door sets.
- Sets of doors lock separately. Keyed alike.
- Includes one adjustable shelf on each side.

| Model No. | Description | Dimensions | Wt. | List Price |
|-------------|-----------------------------|------------------------|------|------------|
| VLC | Wood/Glass Door Combination | 72"W x 19"D x 29 1/2"H | 193# | \$1856 |
| VLCW | All Wood Doors | 72"W x 19"D x 29 1/2"H | 193# | \$1856 |
| VLCG | All Glass Doors | 72"W x 19"D x 29 1/2"H | 193# | \$1856 |

BOOKCASES

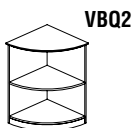
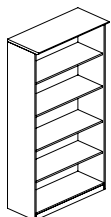
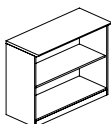

- Open shelves for convenient storage.
- Adjustable shelves.
- VB2 & VB5 support 75 lbs. per shelf, evenly distributed; VBQ2 supports 25 lbs. per shelf, evenly distributed.
- Choice of two or five shelf units.
- 1" thick shelves.

| Model No. | Description | Dimensions | Wt. | List Price |
|-------------|---------------------|------------------------|------|------------|
| VB2 | 2 Shelf | 36"W x 16"D x 29 1/2"H | 64# | \$764 |
| VB5 | 5 Shelf | 36"W x 16"D x 68"H | 140# | \$1480 |
| VBQ2 | 2 Shelf 1/4 - Round | 19"W x 19"D x 29 1/2"H | 25# | \$718 |

NAPOLI RECEPTION FURNITURE

First impressions are critical for any business. The Napoli Reception Furniture is available in two finishes, and features AA-grade North American hardwood veneers throughout.

Surfaces: Sierra Cherry finish on Cherry veneer and Mahogany finish on Walnut veneer.

- All Napoli Reception Stations (except NRS) include a center drawer.
- Non-handed return.
- 3/4" frosted, tempered glass.
- Universal ADA Reception Return can only be used with Napoli Reception Station.

| Model No. | Description | Dimensions | Wt. | List Price |
|---------------|--|--|------|------------|
| NRS | Reception Station (no peds) | 87 1/4"W x 37 1/4"D x 42 3/4"H | 398# | \$3228 |
| NRSBF | Reception Station with B/B/F, F/F | 87 1/4"W x 37 1/4"D x 42 3/4"H | 577# | \$5150 |
| NRSBB | Reception Station with 2-B/B/F | 87 1/4"W x 37 1/4"D x 42 3/4"H | 562# | \$5179 |
| NRSLBF | Reception Station with B/B/F, F/F | 87 1/4"W x 37 1/4"D x 42 3/4"H Desk 48"W x 25"D x 39 1/4"H Return | 980# | \$6752 |
| NRSLBB | Reception Station with 2-B/B/F | 87 1/4"W x 37 1/4"D x 42 3/4"H Desk 48"W x 25"D x 39 1/4"H Return | 980# | \$6764 |
| NRSLFF | Reception Station with 2-F/F | 87 1/4"W x 37 1/4"D x 42 3/4"H Desk 48"W x 25"D x 39 1/4"H Return | 980# | \$6723 |
| NRSLBA | Reception Station with 1-B/B/F Universal ADA Return | 87 1/4"W x 37 1/4"D x 42 3/4"H Desk 38"W x 20 1/2"D x 28 3/4"H Return | 553# | \$4803 |
| NRTNA | Universal ADA Return | 38"W x 20 1/2"D x 28 3/4"H | 64# | \$477 |

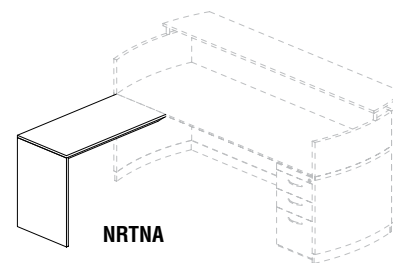
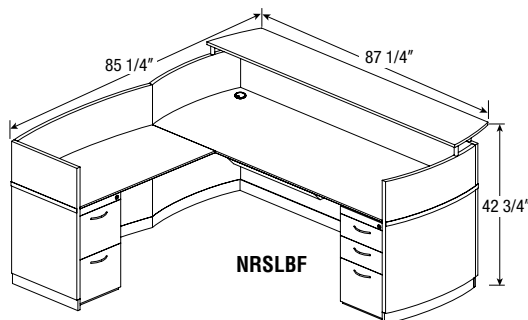
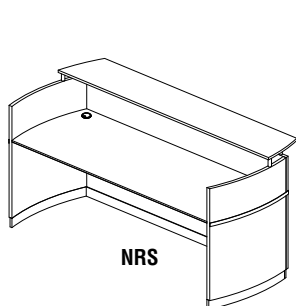

NAPOLI VENEER SERIES

NAPOLI CONFERENCE TABLES

The Napoli veneer conference room furniture features elegant lines with excellent durability. Available in two rich finishes, Napoli features AA-grade select North American hardwood veneers throughout.

Surfaces: Sierra Cherry finish on cherry veneer and Mahogany finish on walnut veneer.

- All veneer surfaces are protected with two coats of high-tech catalyzed lacquer.
- Grommet hole cutout size is 2 3/4" x 6".

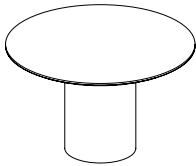

NCR48

| Model No. | Description | Dimensions | Wt. | List Price |
|-----------|------------------------|-------------------------|------|------------|
| NC6 | 6' Conference Table | 72"W x 36"D x 29 1/2"H | 197# | \$1832 |
| NC8 | 8' Conference Table | 96"W x 42"D x 29 1/2"H | 236# | \$2278 |
| NC10 | 10' Conference Table | 120"W x 48"D x 29 1/2"H | 306# | \$3224 |
| NC12 | 12' Conference Table | 144"W x 54"D x 29 1/2"H | 358# | \$5256 |
| NC14 | 14' Conference Table | 168"W x 54"D x 29 1/2"H | 399# | \$5502 |
| NC18 | 18' Conference Table | 216"W x 54"D x 29 1/2"H | 545# | \$7853 |
| NC20 | 20' Conference Table | 240"W x 54"D x 29 1/2"H | 585# | \$8098 |
| NC24 | 24' Conference Table | 288"W x 54"D x 29 1/2"H | 732# | \$10450 |
| NC26 | 26' Conference Table | 312"W x 54"D x 29 1/2"H | 772# | \$10694 |
| NC30 | 30' Conference Table | 360"W x 54"D x 29 1/2"H | 919# | \$13047 |
| NCR48 | Round Conference Table | 48" Round x 29 1/2"H | 135# | \$1514 |
| CTMB | Presentation Board | 48" x 48" x 3 1/4" | 110# | \$1467 |

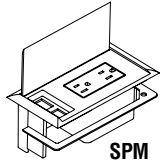
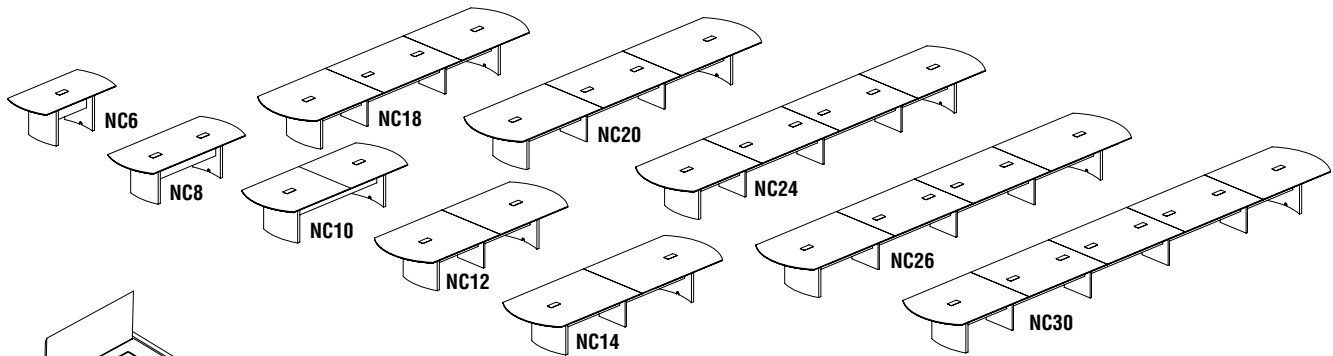

SPM

| Model No. | Description | List Price |
|---|--|------------|
| SPM  | 6 1/4"W x 4"D x 1 1/2"H Optional Power Module, UL Listed [includes RJ11-Cat 3 coupler (phone) and RJ45 coupler (data)] – 6' power cord. Black only. | \$298 |

BUFFET

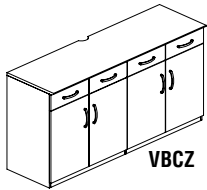

VBCZ

- Features two cabinet compartments (one adjustable shelf in each) and four drawers.
- Designed for audio/visual support including cable pass throughs and inset back panel for wall plug clearance.
- All drawer and cabinet interiors are full-finished veneer.

| Model No. | Dimensions | Wt. | List Price |
|-----------|--------------------|------|------------|
| VBCZ | 72"W x 22"D x 36"H | 297# | \$2972 |

REPLACEMENT LOCK CORES

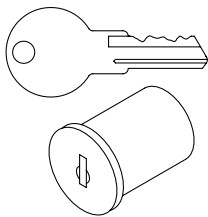

- Allows pedestals and laterals to be keyed uniquely for up to 15 different workstations.
- Master key available.
- Must purchase a core removal tool to change locks cores.

| Model No. | Description | Wt. | List Price |
|--|----------------------------|-----|------------|
| REALCC0311 through REALCC0325 (Silver) | Replacement core with keys | 1# | \$22 |
| REALCRK | Core removal tool | 1# | \$22 |
| REALCMK | Master Key | 1# | \$22 |